

CONFIDENTIAL

This document is the property of Evapco, Inc. It should not be copied or disclosed without prior written authorization.

# EVAPCO, INC.



CUSTOMER

MODEL #  
SSTHB1-2264E0150K1KA

SCALE N.T.S.

DWG. #  
STL1-SE-16-FL

REV. 1

DATE  
4/5/2026

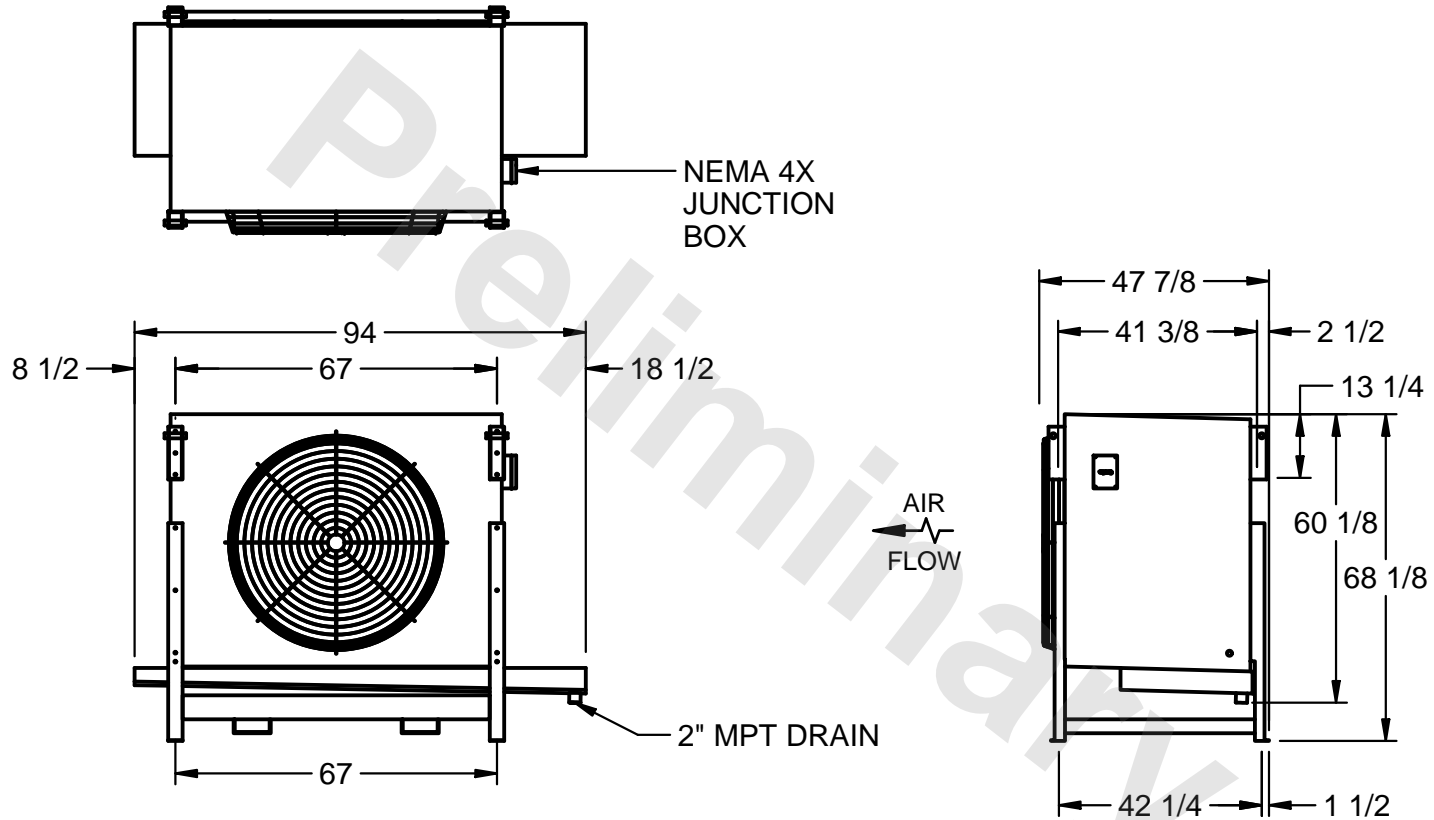

**NOTES:**

- 1) RIGHT HAND MODEL SHOWN.
- 2) ALL DIMENSIONS ARE FOR REFERENCE AND SHOULD NOT BE USED FOR PREFABRICATION OF PIPING OR SUPPORTS.
- 3) WATER DEFROST ADDS 6 INCHES TO HEIGHT OF STANDARD UNIT AND CHANGES DRAIN SIZE.
- 4) HANGER HOLES ARE FOR 3/4 INCH THREADED ROD.

PROJECT

ROOM

SHIPPING WEIGHT 1330 lbs

OPERATING WEIGHT 1520 lbs