

CONFIDENTIAL  
This document is the property of Evapco, Inc. It should not be copied or disclosed without prior written authorization.

EVAPCO, INC.

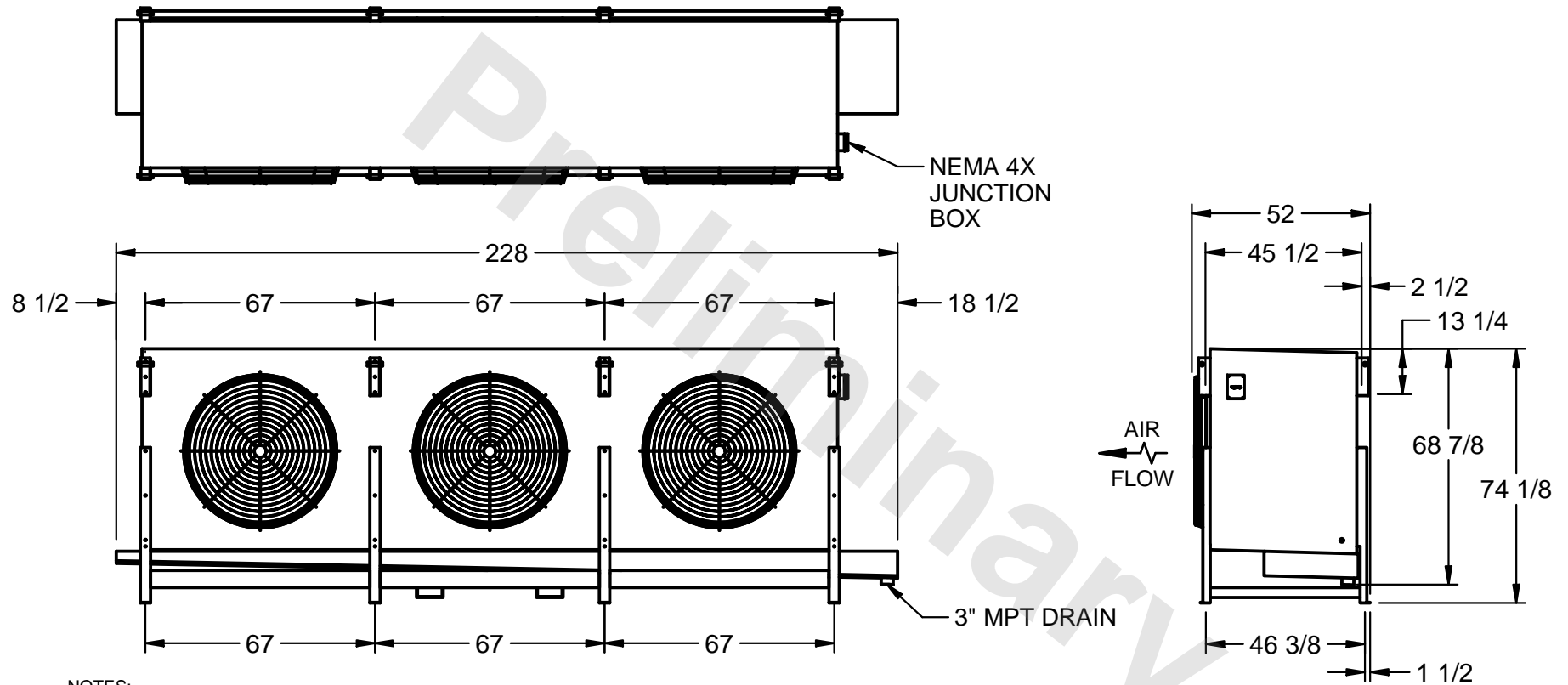

CUSTOMER MODEL # SSTHB3-75103E0200K2KA SCALE N.T.S. DWG. # STL3-SE-18-10R-FL REV. 1 DATE 4/6/2026



NOTES:

- 1) RIGHT HAND MODEL SHOWN.
- 2) ALL DIMENSIONS ARE FOR REFERENCE AND SHOULD NOT BE USED FOR PREFABRICATION OF PIPING OR SUPPORTS.
- 3) WATER DEFROST ADDS 6 INCHES TO HEIGHT OF STANDARD UNIT AND CHANGES DRAIN SIZE.
- 4) HANGER HOLES ARE FOR 3/4 INCH THREADED ROD.

PROJECT ROOM SHIPPING WEIGHT 4060 lbs OPERATING WEIGHT 4960 lbs