

**CONFIDENTIAL**

This document is the property of Evapco, Inc. It should not be copied or disclosed without prior written authorization.

**EVAPCO, INC.**



CUSTOMER	MODEL # SSTHB4-898VF0300K3LA	SCALE N.T.S.	DWG. # STL4-SE-16-FL	REV. 1	DATE 4/4/2026
----------	---------------------------------	-----------------	-------------------------	--------	------------------

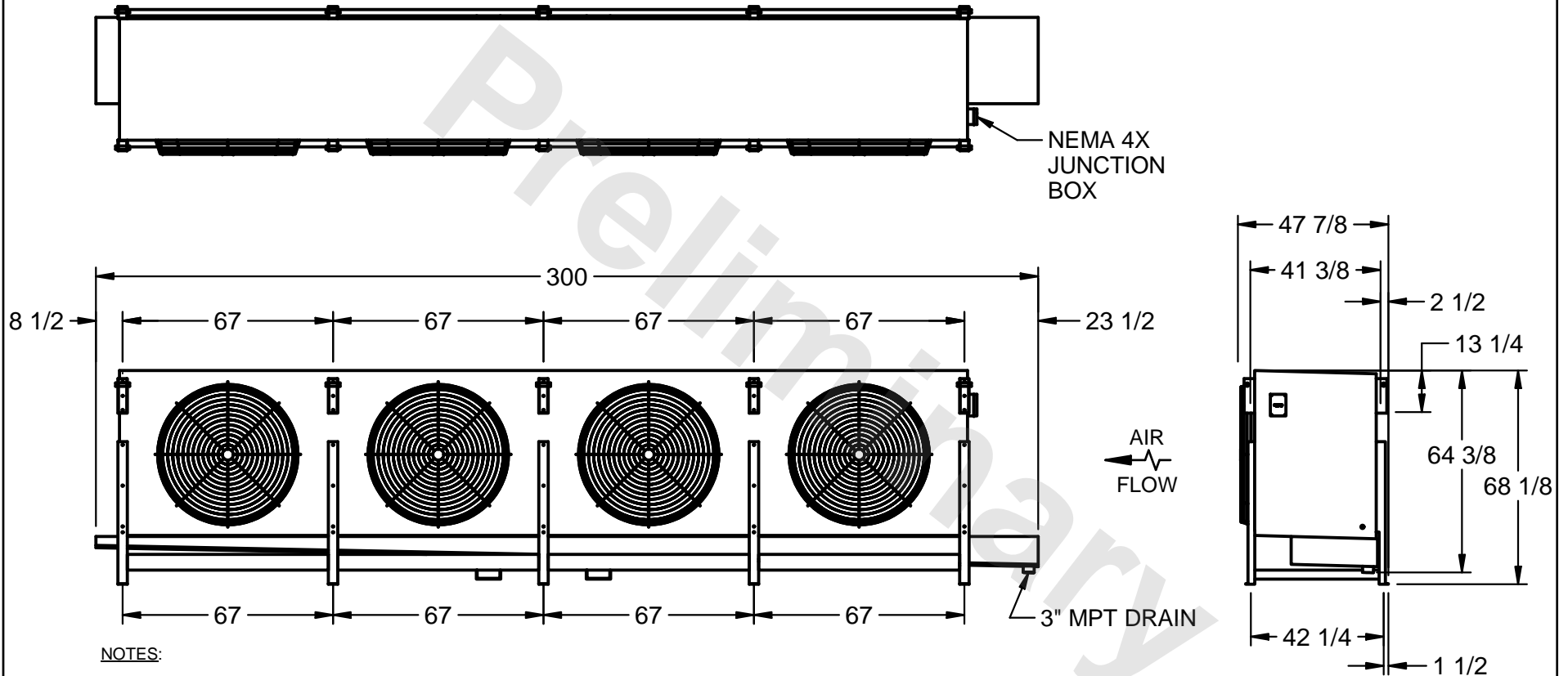

**NOTES:**

- 1) RIGHT HAND MODEL SHOWN.
- 2) ALL DIMENSIONS ARE FOR REFERENCE AND SHOULD NOT BE USED FOR PREFABRICATION OF PIPING OR SUPPORTS.
- 3) WATER DEFROST ADDS 6 INCHES TO HEIGHT OF STANDARD UNIT AND CHANGES DRAIN SIZE.
- 4) HANGER HOLES ARE FOR 3/4 INCH THREADED ROD.

PROJECT	ROOM	SHIPPING WEIGHT 4660 lbs	OPERATING WEIGHT 5310 lbs
---------	------	--------------------------	---------------------------