

UNIT	COOLING TOWER	
MODEL #	AT 124-4S30-EV	SCALE NTS

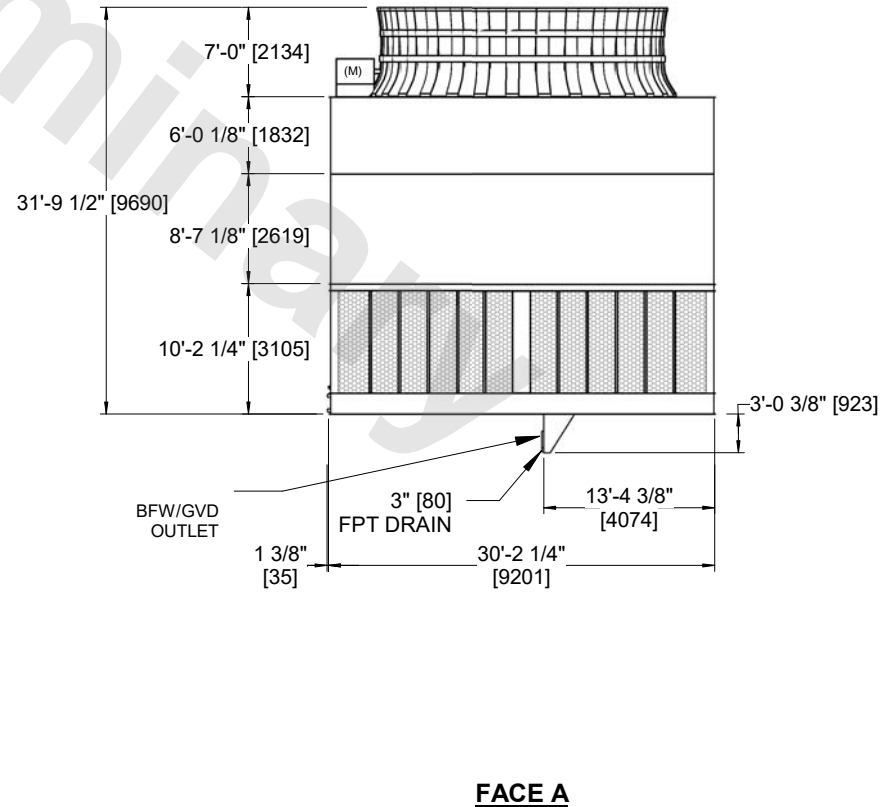

DWG. #	ATL4BI24304E5T-DRC-DS	REV	-
SERIAL #		DATE:	7/8/2026

- NOTES
1. (M)- FAN MOTOR LOCATION
 2. HEAVIEST SECTION IS CASING SECTION
 3. MPT DENOTES MALE PIPE THREAD
FPT DENOTES FEMALE PIPE THREAD
BFW DENOTES BEVELED FOR WELDING
GVD DENOTES GROOVED
FLG DENOTES FLANGE
 4. +UNIT WEIGHT DOES NOT INCLUDE ACCESSORIES (SEE ACCESSORY DRAWINGS)
 5. 3/4" [19mm] DIA. MOUNTING HOLES. REFER TO RECOMMENDED STEEL SUPPORT DRAWING
 6. DIMENSIONS LISTED AS FOLLOWS
ENGLISH FT-IN
[METRIC] [mm]
 7. FOR BOTTOM INLET SPECIFICATIONS, SEE DETAIL.

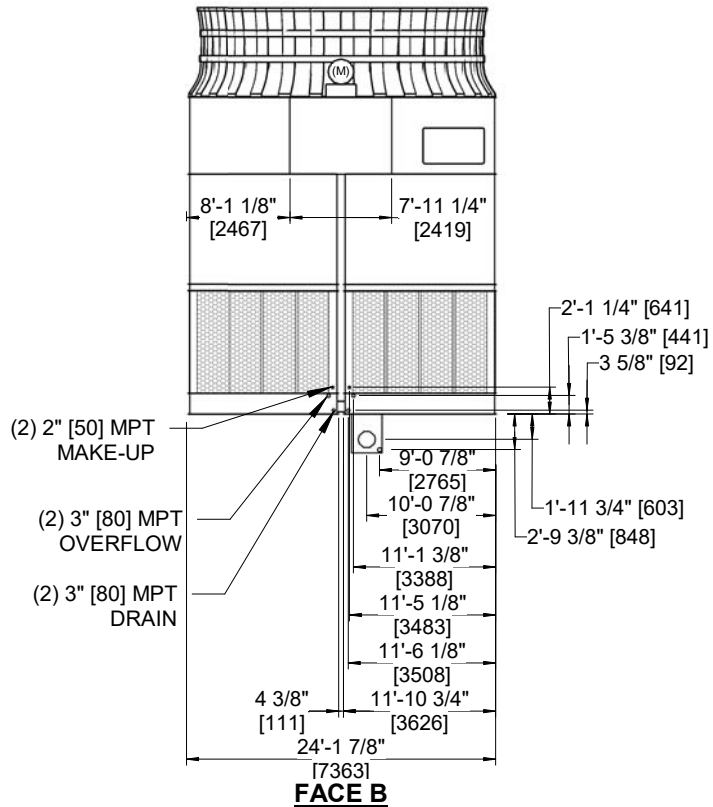
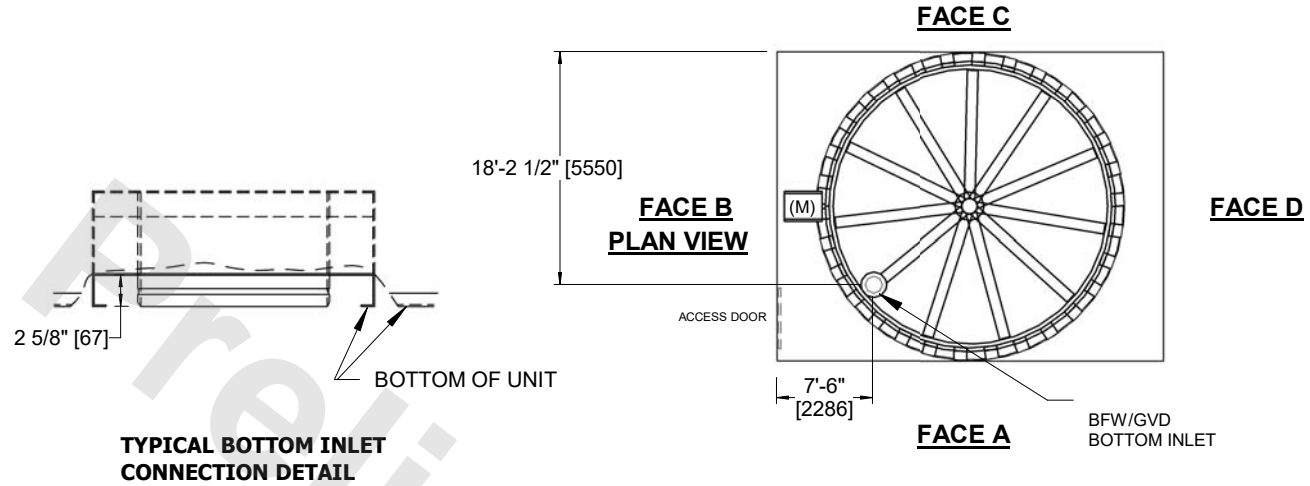

SHIPPING WEIGHT	69010 lbs+ [31305] kg+	OPERATING WEIGHT	95540 lbs+ [43340] kg+	HEAVIEST SECTION WEIGHT	12320 lbs+ [5590] kg+	NO. OF SHIPPING SECTIONS	7	DRAWN BY:	JLG
-----------------	------------------------	------------------	------------------------	-------------------------	-----------------------	--------------------------	---	-----------	-----