

UNIT	COOLING TOWER	
MODEL #	AT 248-4R30-EV	SCALE NTS



DWG. #	ATL4BI48304E5T-DRC-DS	REV	-
SERIAL #		DATE:	5/24/2026

- NOTES
- (M)- FAN MOTOR LOCATION
 - HEAVIEST SECTION IS CASING SECTION
 - MPT DENOTES MALE PIPE THREAD
FPT DENOTES FEMALE PIPE THREAD
BFW DENOTES BEVELED FOR WELDING
GVD DENOTES GROOVED
FLG DENOTES FLANGE
 - +UNIT WEIGHT DOES NOT INCLUDE ACCESSORIES (SEE ACCESSORY DRAWINGS)
 - 3/4" [19mm] DIA. MOUNTING HOLES. REFER TO RECOMMENDED STEEL SUPPORT DRAWING
 - DIMENSIONS LISTED AS FOLLOWS
ENGLISH FT-IN
[METRIC] [mm]
 - FOR BOTTOM INLET SPECIFICATIONS, SEE DETAIL.



TYPICAL BOTTOM INLET CONNECTION DETAIL

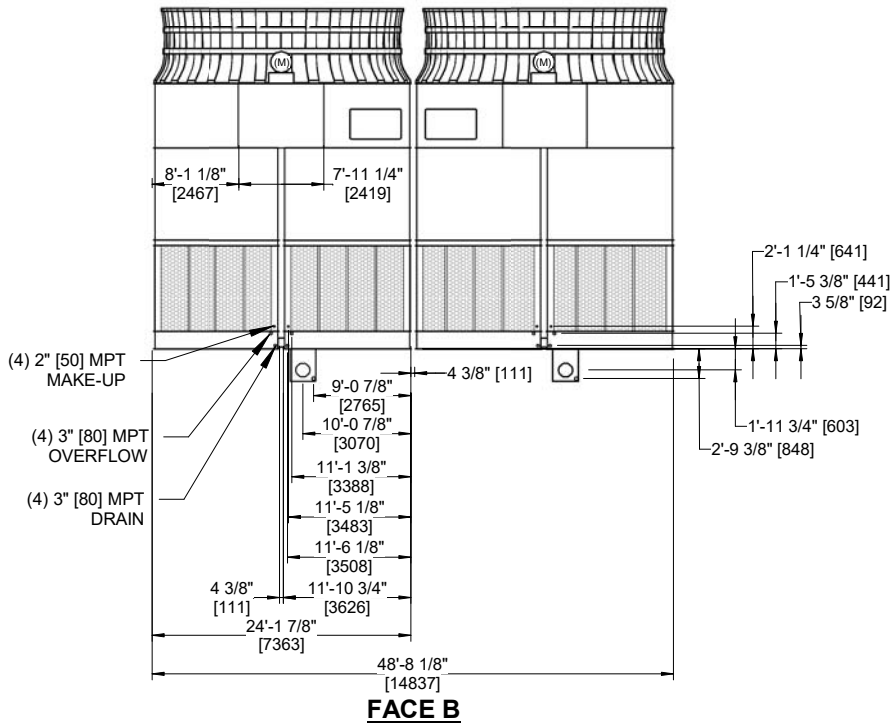
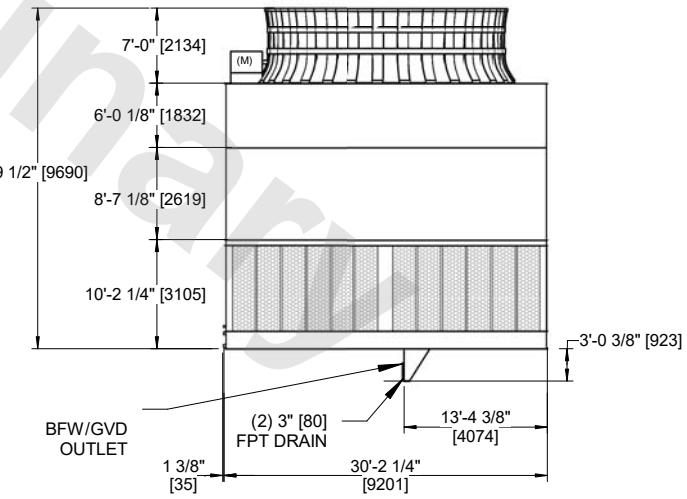

FACE B

FACE A

SHIPPING WEIGHT	136200 lbs+ [61780] kg+	OPERATING WEIGHT	189260 lbs+ [85850] kg+	HEAVIEST SECTION WEIGHT	12320 lbs+ [5590] kg+	NO. OF SHIPPING SECTIONS	14	DRAWN BY:	JLG
-----------------	-------------------------	------------------	-------------------------	-------------------------	-----------------------	--------------------------	----	-----------	-----