

UNIT CLOSED CIRCUIT COOLER
 MODEL # ESW4 14-32M22-LP SCALE NTS

EVAPCO, INC.

DWG. # WX414223604-DRB-ST REV -
 SERIAL # DATE: 4/24/2026

- NOTES:
- (M)- FAN MOTOR LOCATION
 - HEAVIEST SECTION IS COIL SECTION
 - MPT DENOTES MALE PIPE THREAD
 FPT DENOTES FEMALE PIPE THREAD
 BFW DENOTES BEVELED FOR WELDING
 GVD DENOTES GROOVED
 FLG DENOTES FLANGE
 - +UNIT WEIGHT DOES NOT INCLUDE ACCESSORIES (SEE ACCESSORY DRAWINGS)
 - 3/4" [19MM] DIA. MOUNTING HOLES. REFER TO RECOMMENDED STEEL SUPPORT DRAWING
 - MAKE-UP WATER PRESSURE
 20 psi MIN [137 kPa], 50 psi MAX [344 kPa]
 - DIMENSIONS LISTED AS FOLLOWS:
 ENGLISH FT-IN
 [METRIC] [mm]
 - * - APPROXIMATE DIMENSIONS DO NOT USE FOR PRE-FABRICATION OF CONNECTING PIPING

**FACE B
 PLAN VIEW**

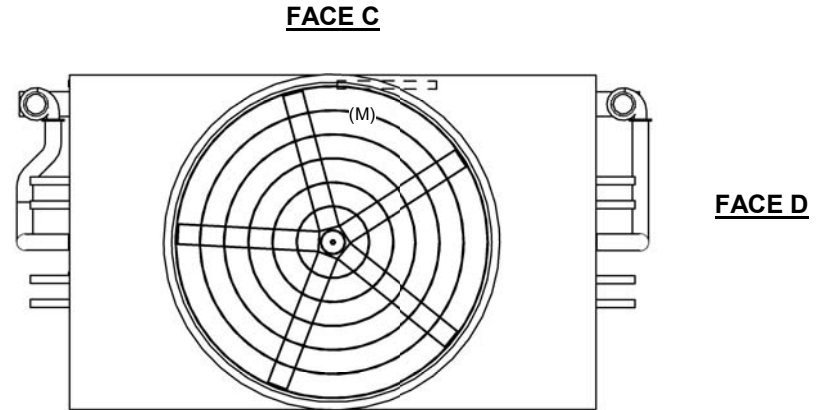

FACE A



FACE B

FACE A

MODEL NUMBER	DIMENSION A
ESW4 14-32*22-LP	2'-1 3/4"
ESW4 14-32*22-AP	2'-7 1/4"

SHIPPING WEIGHT 31470 lbs+ [14275] kg+

OPERATING WEIGHT 47960 lbs+ [21755] kg+

HEAVIEST SECTION WEIGHT 19240 lbs+ [8730] kg+

NO. OF SHIPPING SECTIONS 2

DRAWN BY: JLG