

UNIT CLOSED CIRCUIT COOLER
 MODEL # ESW4 14-44M22-LP SCALE NTS

EVAPCO, INC.

DWG. # WX414224808-DRB-ST REV -
 SERIAL # DATE: 4/29/2026

- NOTES:
1. (M)- FAN MOTOR LOCATION
 2. HEAVIEST SECTION IS COIL SECTION
 3. MPT DENOTES MALE PIPE THREAD
 FPT DENOTES FEMALE PIPE THREAD
 BFW DENOTES BEVELED FOR WELDING
 GVD DENOTES GROOVED
 FLG DENOTES FLANGE
 4. +UNIT WEIGHT DOES NOT INCLUDE ACCESSORIES (SEE ACCESSORY DRAWINGS)
 5. 3/4" [19MM] DIA. MOUNTING HOLES. REFER TO RECOMMENDED STEEL SUPPORT DRAWING
 6. MAKE-UP WATER PRESSURE
 20 psi MIN [137 kPa], 50 psi MAX [344 kPa]
 7. DIMENSIONS LISTED AS FOLLOWS:
 ENGLISH FT-IN
 [METRIC] [mm]
 8. * - APPROXIMATE DIMENSIONS DO NOT USE FOR PRE-FABRICATION OF CONNECTING PIPING

**FACE B
 PLAN VIEW**



FACE A

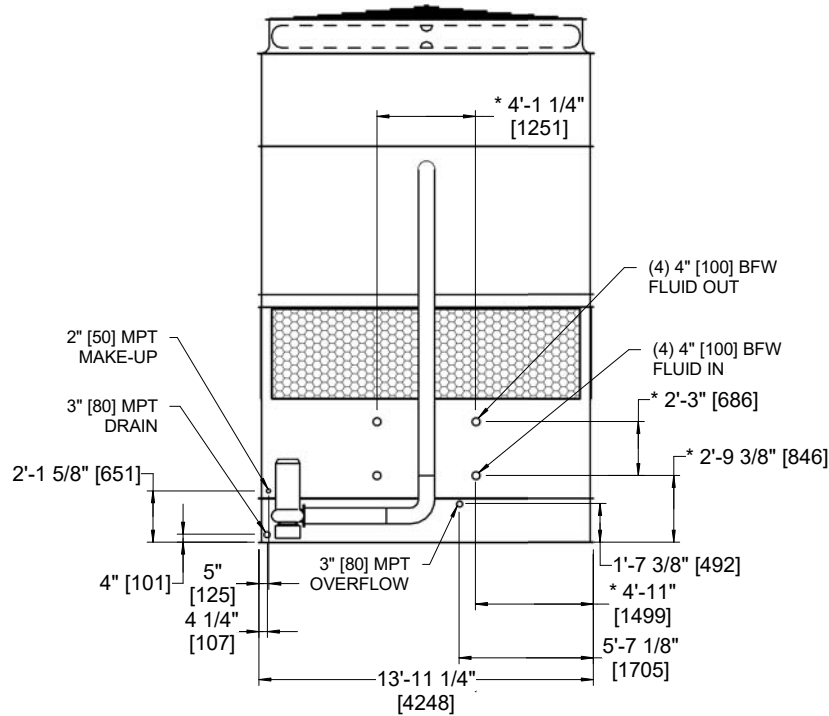

FACE B

FACE A

MODEL NUMBER	DIMENSION A
ESW4 14-44*22-LP	2'-1 3/4"
ESW4 14-44*22-AP	2'-7 1/4"

SHIPPING WEIGHT 40140 lbs+ [18210] kg+

OPERATING WEIGHT 59380 lbs+ [26935] kg+

HEAVIEST SECTION WEIGHT 26890 lbs+ [12200] kg+

NO. OF SHIPPING SECTIONS 2

DRAWN BY: JLG