

UNIT	CLOSED CIRCUIT COOLER
MODEL #	ESW4 9-4316-LP
SCALE	NTS

EVAPCO, INC.



DWG. #	WX409064806P-DRA-ST	REV	-
SERIAL #		DATE:	5/5/2026

- NOTES:
- (M)- FAN MOTOR LOCATION
 - HEAVIEST SECTION IS COIL SECTION
 - MPT DENOTES MALE PIPE THREAD
FPT DENOTES FEMALE PIPE THREAD
BFW DENOTES BEVELED FOR WELDING
GVD DENOTES GROOVED
FLG DENOTES FLANGE
 - +UNIT WEIGHT DOES NOT INCLUDE ACCESSORIES (SEE ACCESSORY DRAWINGS)
 - 3/4" [19MM] DIA. MOUNTING HOLES. REFER TO RECOMMENDED STEEL SUPPORT DRAWING
 - MAKE-UP WATER PRESSURE
20 psi MIN [137 kPa], 50 psi MAX [344 kPa]
 - DIMENSIONS LISTED AS FOLLOWS:
ENGLISH FT-IN
[METRIC] [mm]
 - * - APPROXIMATE DIMENSIONS DO NOT USE FOR PRE-FABRICATION OF CONNECTING PIPING

FACE C



**FACE B
PLAN VIEW**

FACE D

FACE A

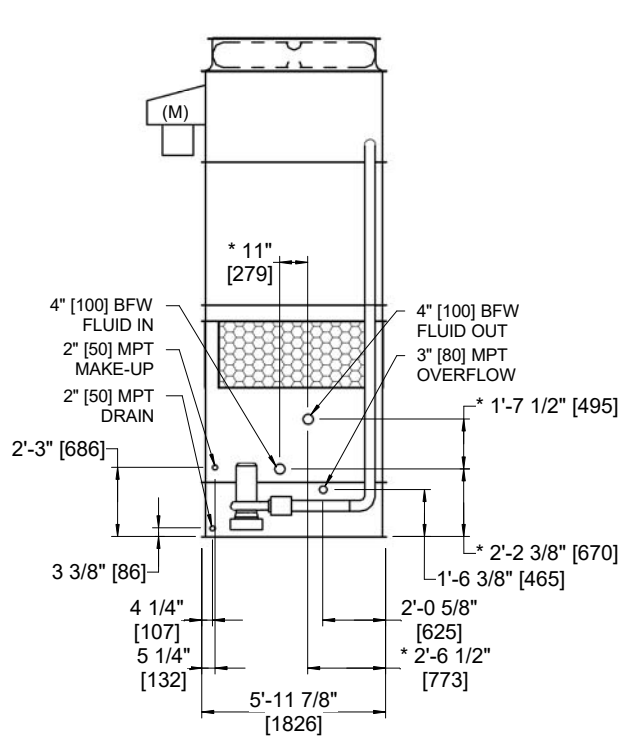

FACE B

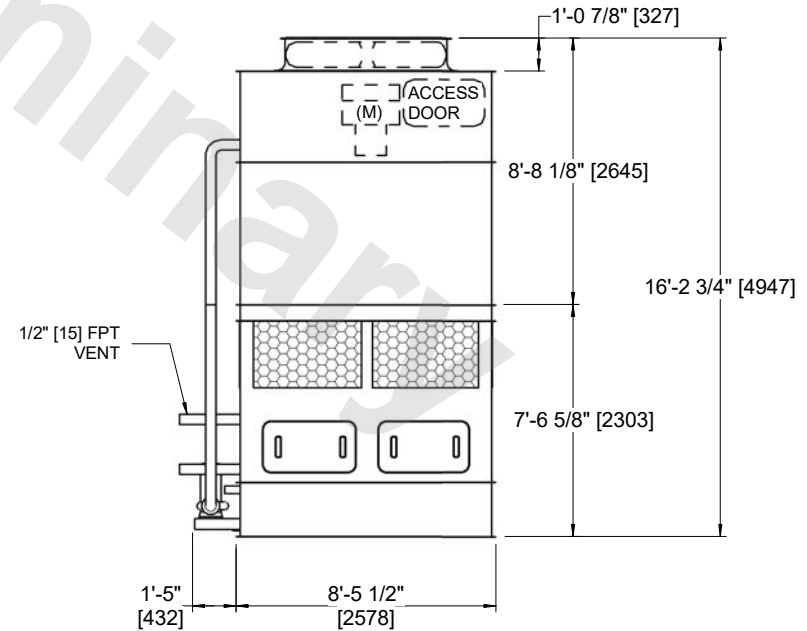

FACE A

SHIPPING WEIGHT	7260 lbs+ [3295] kg+	OPERATING WEIGHT	10140 lbs+ [4600] kg+	HEAVIEST SECTION WEIGHT	4770 lbs+ [2165] kg+	NO. OF SHIPPING SECTIONS	2	DRAWN BY:	AWT
-----------------	----------------------	------------------	-----------------------	-------------------------	----------------------	--------------------------	---	-----------	-----