

| | |
|---------|-----------------------|
| UNIT | CLOSED CIRCUIT COOLER |
| MODEL # | ESW4 9-23G9-LP |
| SCALE | NTS |

EVAPCO, INC.



| | | | |
|----------|---------------------|-------|----------|
| DWG. # | WX409092406P-DRA-ST | REV | - |
| SERIAL # | | DATE: | 7/4/2026 |

- NOTES:
- (M)- FAN MOTOR LOCATION
 - HEAVIEST SECTION IS COIL SECTION
 - MPT DENOTES MALE PIPE THREAD
FPT DENOTES FEMALE PIPE THREAD
BFW DENOTES BEVELED FOR WELDING
GVD DENOTES GROOVED
FLG DENOTES FLANGE
 - +UNIT WEIGHT DOES NOT INCLUDE ACCESSORIES (SEE ACCESSORY DRAWINGS)
 - 3/4" [19MM] DIA. MOUNTING HOLES. REFER TO RECOMMENDED STEEL SUPPORT DRAWING
 - MAKE-UP WATER PRESSURE
20 psi MIN [137 kPa], 50 psi MAX [344 kPa]
 - DIMENSIONS LISTED AS FOLLOWS:
ENGLISH FT-IN
[METRIC] [mm]
 - * - APPROXIMATE DIMENSIONS DO NOT USE FOR PRE-FABRICATION OF CONNECTING PIPING

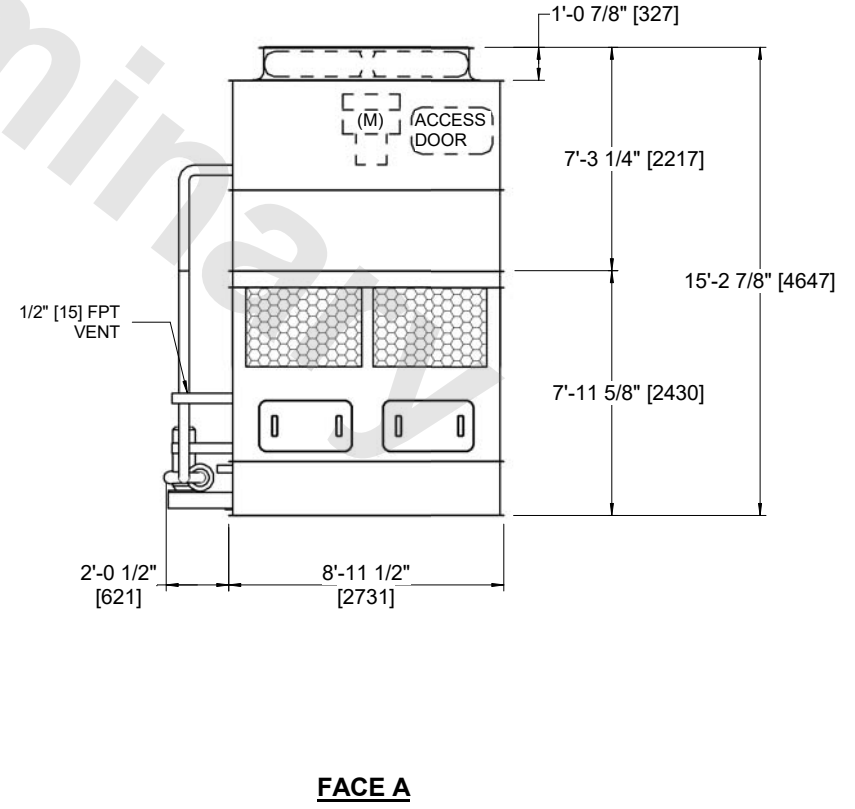
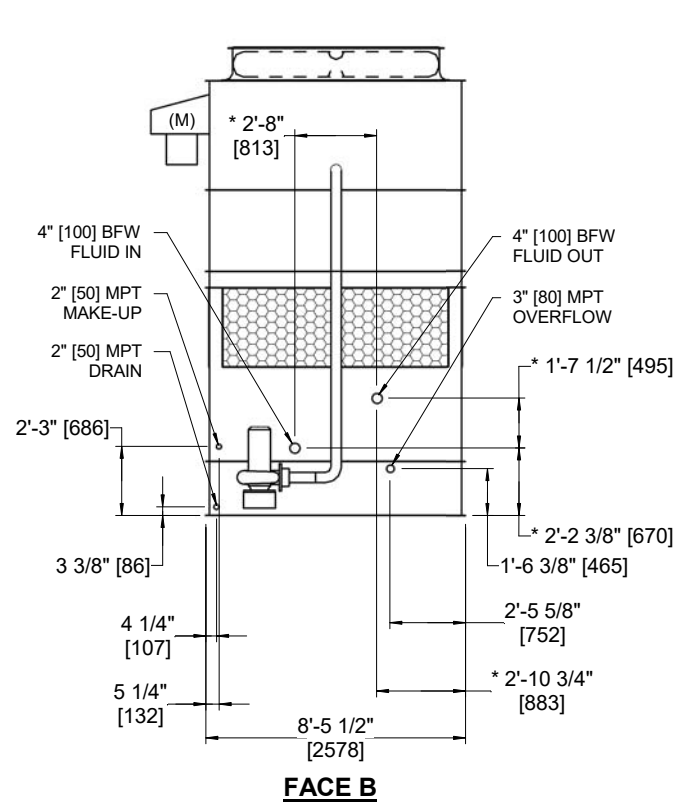

| | | | | | | | | | |
|-----------------|----------------------|------------------|-----------------------|-------------------------|----------------------|--------------------------|---|-----------|-----|
| SHIPPING WEIGHT | 9710 lbs+ [4405] kg+ | OPERATING WEIGHT | 13860 lbs+ [6290] kg+ | HEAVIEST SECTION WEIGHT | 6990 lbs+ [3170] kg+ | NO. OF SHIPPING SECTIONS | 2 | DRAWN BY: | AWT |
|-----------------|----------------------|------------------|-----------------------|-------------------------|----------------------|--------------------------|---|-----------|-----|