

UNIT	CLOSED CIRCUIT COOLER
MODEL #	ESW4 9-36J9-LP
SCALE	NTS

EVAPCO, INC.



DWG. #	WX409093612P-DRA-ST	REV	-
SERIAL #		DATE:	5/6/2026

- NOTES:
- (M)- FAN MOTOR LOCATION
 - HEAVIEST SECTION IS COIL SECTION
 - MPT DENOTES MALE PIPE THREAD
FPT DENOTES FEMALE PIPE THREAD
BFW DENOTES BEVELED FOR WELDING
GVD DENOTES GROOVED
FLG DENOTES FLANGE
 - +UNIT WEIGHT DOES NOT INCLUDE ACCESSORIES (SEE ACCESSORY DRAWINGS)
 - 3/4" [19MM] DIA. MOUNTING HOLES. REFER TO RECOMMENDED STEEL SUPPORT DRAWING
 - MAKE-UP WATER PRESSURE
20 psi MIN [137 kPa], 50 psi MAX [344 kPa]
 - DIMENSIONS LISTED AS FOLLOWS:
ENGLISH FT-IN
[METRIC] [mm]
 - * - APPROXIMATE DIMENSIONS DO NOT USE FOR PRE-FABRICATION OF CONNECTING PIPING

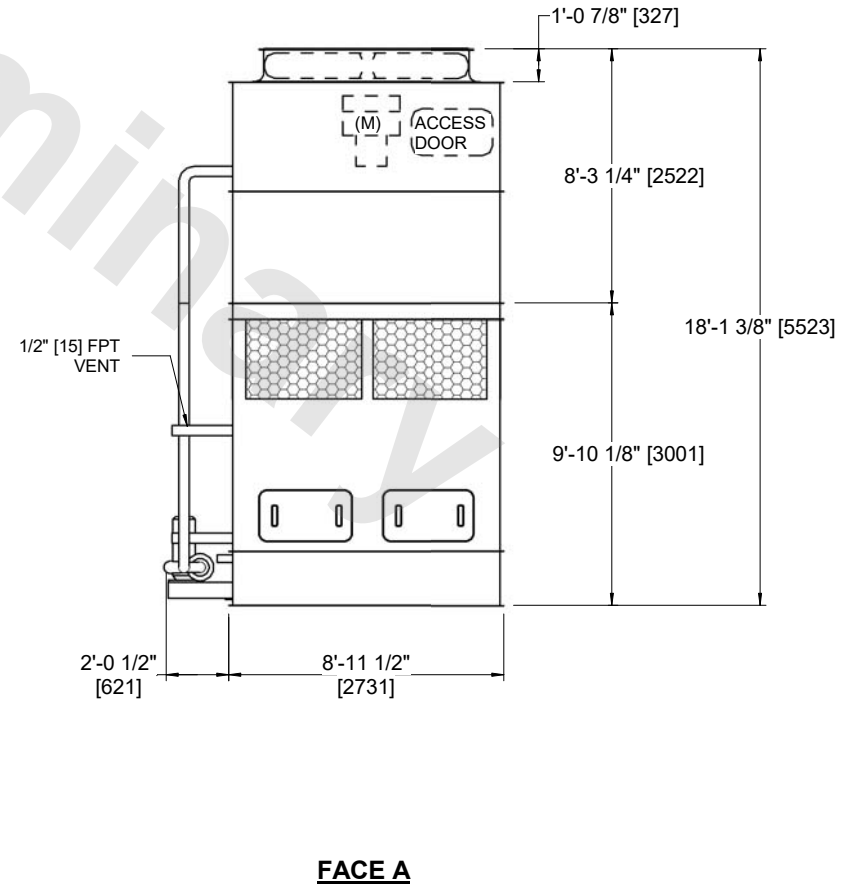
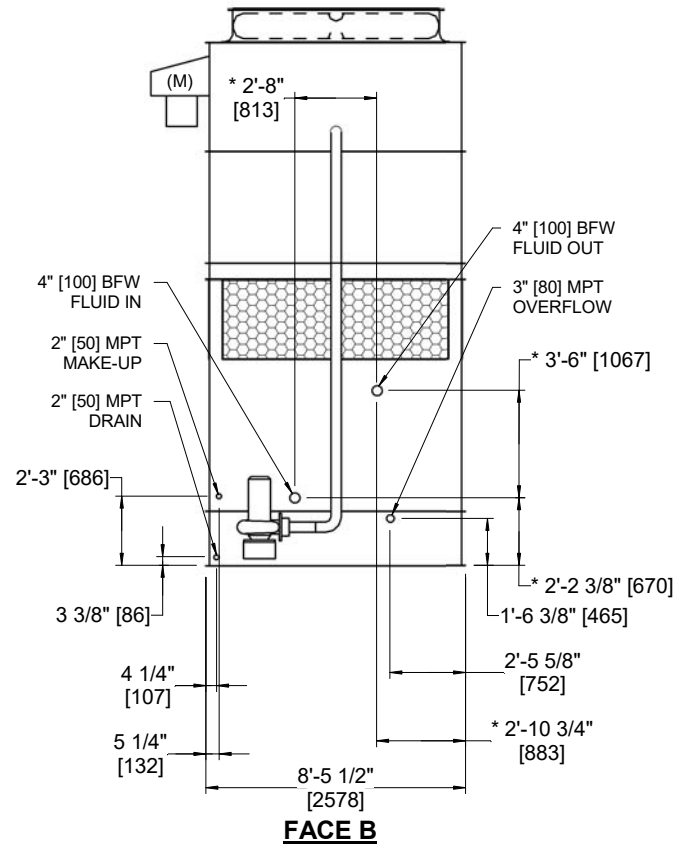
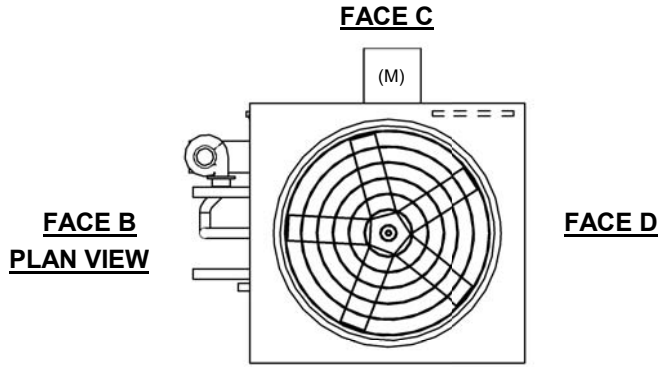

SHIPPING WEIGHT	13570 lbs+ [6160] kg+	OPERATING WEIGHT	18900 lbs+ [8575] kg+	HEAVIEST SECTION WEIGHT	10440 lbs+ [4735] kg+	NO. OF SHIPPING SECTIONS	2	DRAWN BY:	AWT
-----------------	-----------------------	------------------	-----------------------	-------------------------	-----------------------	--------------------------	---	-----------	-----