

UNIT	COOLING TOWER	
MODEL #	AT 27-2J28	SCALE NTS



DWG. #	CT4C072824-DRA-ST	REV	-
SERIAL #		DATE:	4/7/2026

**NOTES:**

- (M)- FAN MOTOR LOCATION
- HEAVIEST SECTION IS FAN/CASING SECTION
- MPT DENOTES MALE PIPE THREAD  
FPT DENOTES FEMALE PIPE THREAD  
BFW DENOTES BEVELED FOR WELDING  
GVD DENOTES GROOVED  
FLG DENOTES FLANGE
- +UNIT WEIGHT DOES NOT INCLUDE ACCESSORIES (SEE ACCESSORY DRAWINGS)
- 3/4" [19MM] DIA. MOUNTING HOLES. REFER TO RECOMMENDED STEEL SUPPORT DRAWING
- DIMENSIONS LISTED AS FOLLOWS:  
ENGLISH FT-IN  
[METRIC] [mm]
- MAKE-UP WATER PRESSURE  
20 psi MIN [137 kPa], 50 psi MAX [344 kPa]

**FACE B  
PLAN VIEW**

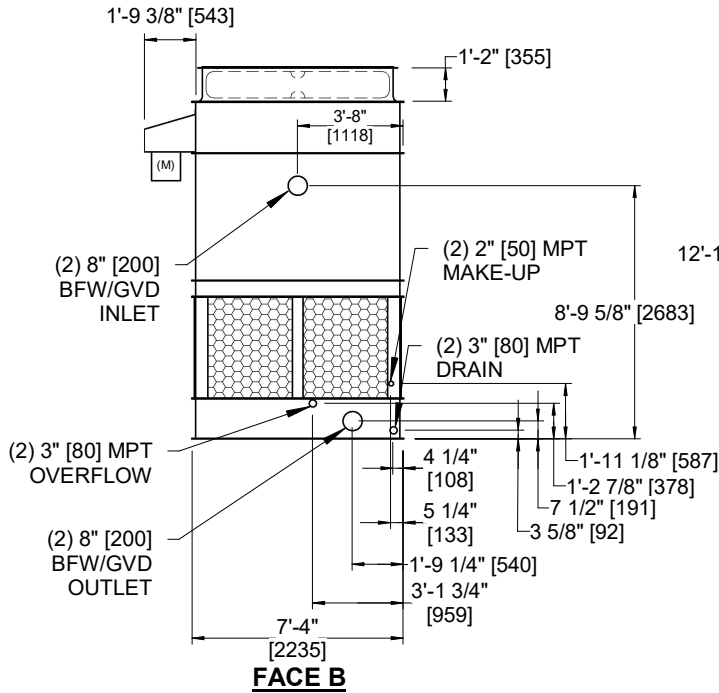
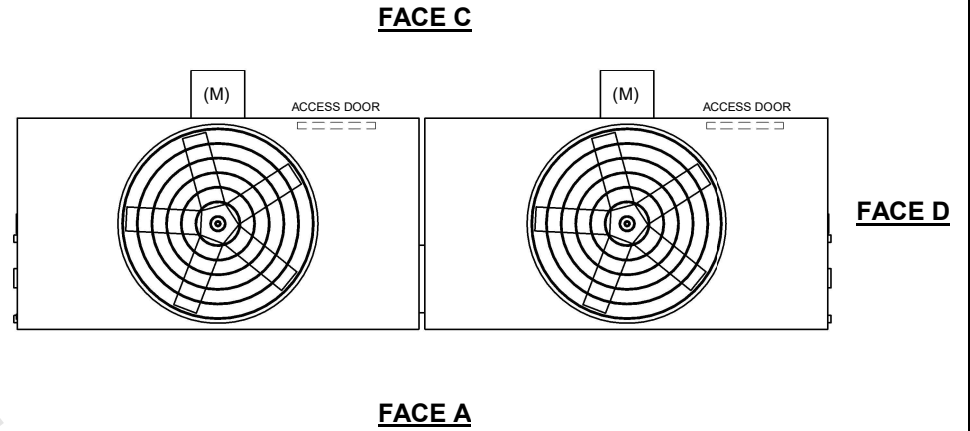

**FACE B**

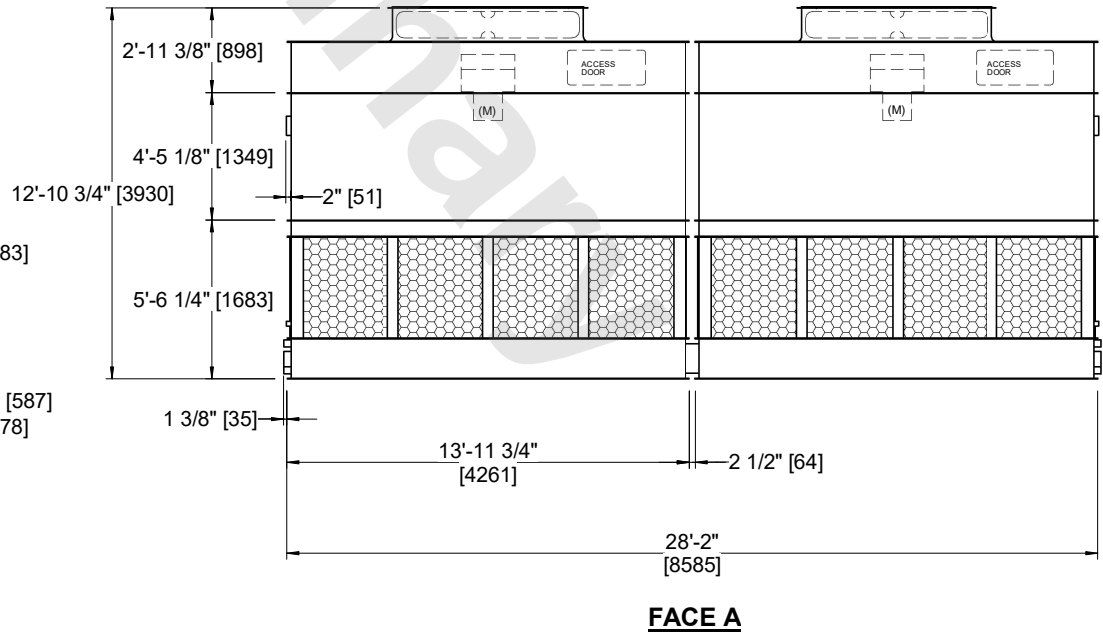

**FACE A**

SHIPPING WEIGHT	10960 lbs+ [4975] kg+	OPERATING WEIGHT	18810 lbs+ [8535] kg+	HEAVIEST SECTION WEIGHT	3480 lbs+ [1580] kg+	NO. OF SHIPPING SECTIONS	4	DRAWN BY:	JLG
-----------------	-----------------------	------------------	-----------------------	-------------------------	----------------------	--------------------------	---	-----------	-----