

UNIT	COOLING TOWER	
MODEL #	AT 17-4J12	SCALE NTS

EVAPCO, INC.

DWG. #	CT4C071248-DRA-ST	REV.	-
SERIAL #		DATE	6/30/2026

- NOTES:
- (M)- FAN MOTOR LOCATION
 - HEAVIEST SECTION IS FAN/CASING SECTION
 - MPT DENOTES MALE PIPE THREAD
FPT DENOTES FEMALE PIPE THREAD
BFW DENOTES BEVELED FOR WELDING
GVD DENOTES GROOVED
FLG DENOTES FLANGE
 - +UNIT WEIGHT DOES NOT INCLUDE ACCESSORIES (SEE ACCESSORY DRAWINGS)
 - 3/4" [19MM] DIA. MOUNTING HOLES. REFER TO RECOMMENDED STEEL SUPPORT DRAWING
 - DIMENSIONS LISTED AS FOLLOWS:
ENGLISH FT-IN
[METRIC] [mm]
 - MAKE-UP WATER PRESSURE
20 psi MIN [137 kPa], 50 psi MAX [344 kPa]

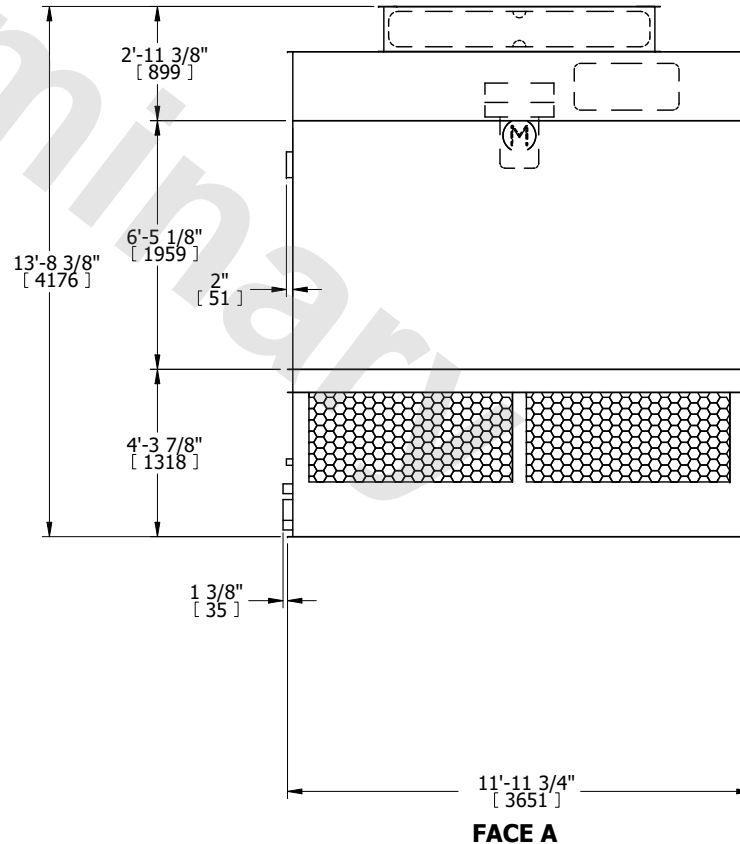
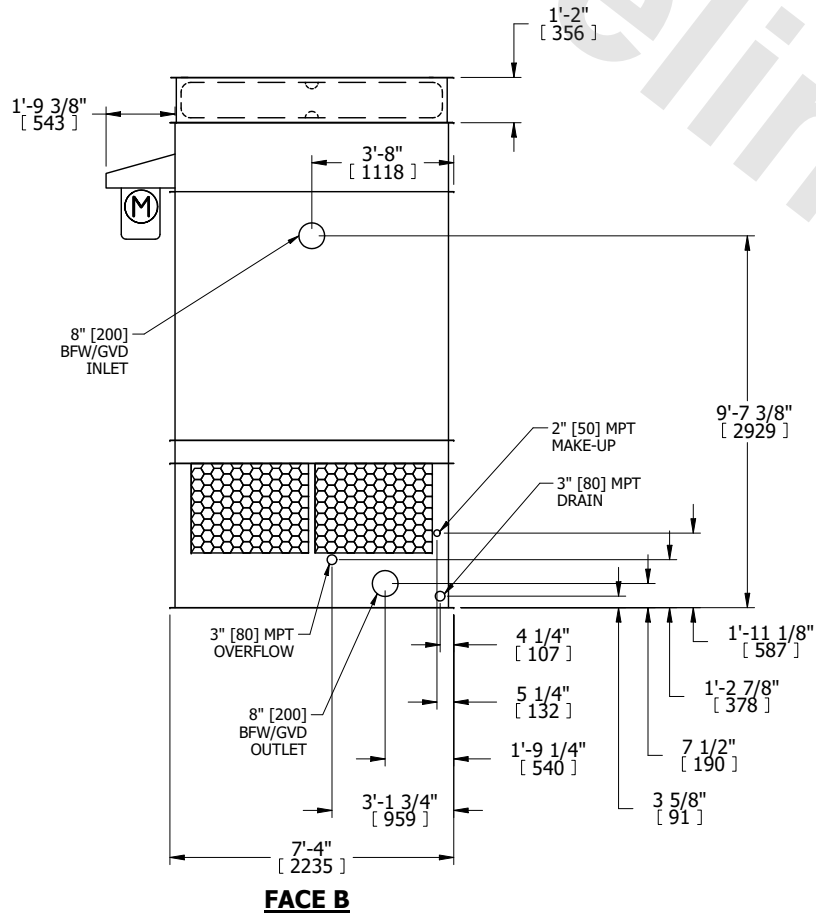
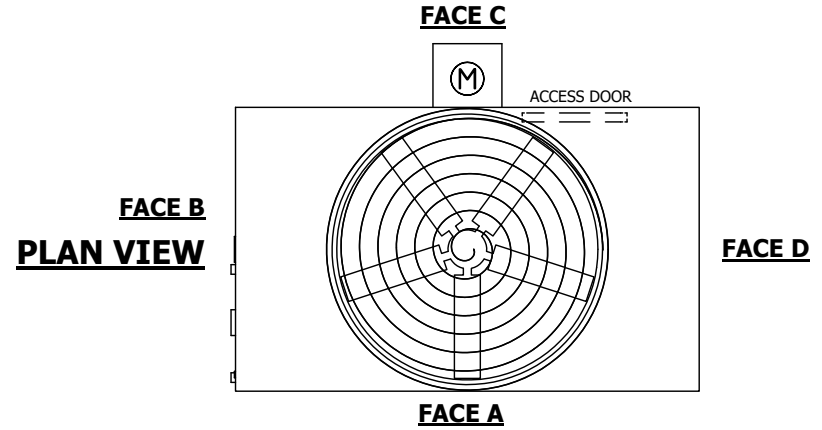

SHIPPING WEIGHT	5490 lbs+ [2495] kg+	OPERATING WEIGHT	8850 lbs+ [4015] kg+	HEAVIEST SECTION WEIGHT	3840 lbs+ [1745] kg+	NO. OF SHIPPING SECTIONS	2	DRAWN BY:	MBG
-----------------	----------------------	------------------	----------------------	-------------------------	----------------------	--------------------------	---	-----------	-----