

| | | |
|---------|---------------|-----------|
| UNIT | COOLING TOWER | |
| MODEL # | AT 314-4L72 | SCALE NTS |

EVAPCO, INC.

| | | | |
|----------|-----------------|------|-----------|
| DWG. # | T4147248-DRA-ST | REV. | - |
| SERIAL # | | DATE | 6/29/2026 |

- NOTES:
- (M)- FAN MOTOR LOCATION
 - HEAVIEST SECTION IS UPPER SECTION
 - MPT DENOTES MALE PIPE THREAD
FPT DENOTES FEMALE PIPE THREAD
BFW DENOTES BEVELED FOR WELDING
GVD DENOTES GROOVED
FLG DENOTES FLANGE
PE DENOTES PLAIN END
 - +UNIT WEIGHT DOES NOT INCLUDE ACCESSORIES (SEE ACCESSORY DRAWINGS)
 - MAKE-UP WATER PRESSURE
20 psi MIN [137 kPa], 50 psi MAX [344 kPa]
 - 3/4" [19MM] DIA. MOUNTING HOLES.
REFER TO RECOMMENDED STEEL SUPPORT DRAWING
 - DIMENSIONS LISTED AS FOLLOWS:
ENGLISH FT-IN
[METRIC] [mm]

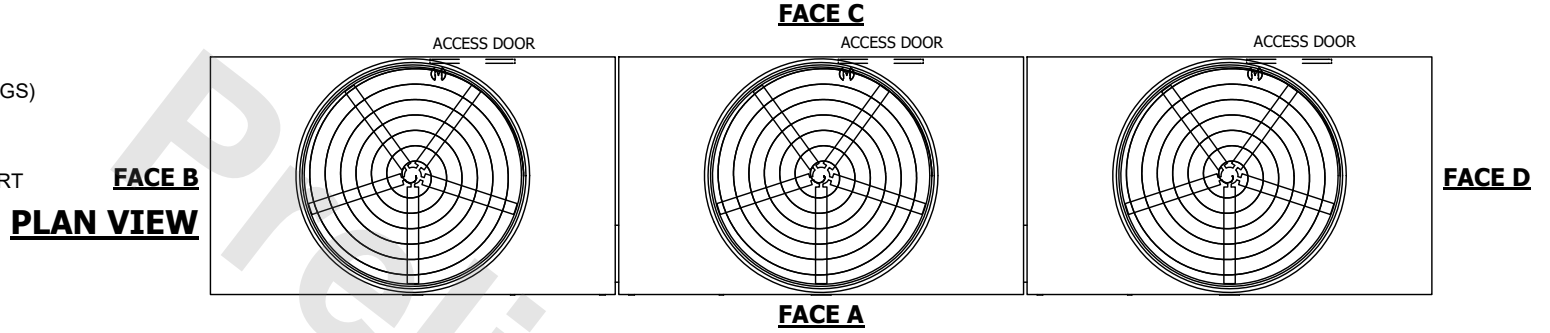

| | | | | | | | | | |
|-----------------|------------------------|------------------|-------------------------|-------------------------|-----------------------|--------------------------|---|-----------|-----|
| SHIPPING WEIGHT | 56370 lbs+ [25570] kg+ | OPERATING WEIGHT | 100560 lbs+ [45615] kg+ | HEAVIEST SECTION WEIGHT | 12730 lbs+ [5775] kg+ | NO. OF SHIPPING SECTIONS | 6 | DRAWN BY: | MER |
|-----------------|------------------------|------------------|-------------------------|-------------------------|-----------------------|--------------------------|---|-----------|-----|