

|         |               |           |
|---------|---------------|-----------|
| UNIT    | COOLING TOWER |           |
| MODEL # | AT 214-4112   | SCALE NTS |

# EVAPCO, INC.

|          |                   |      |           |
|----------|-------------------|------|-----------|
| DWG. #   | CT4C141248-DRA-ST | REV. | -         |
| SERIAL # |                   | DATE | 4/12/2026 |

- NOTES:
- (M)- FAN MOTOR LOCATION
  - HEAVIEST SECTION IS FAN/CASING SECTION
  - MPT DENOTES MALE PIPE THREAD  
FPT DENOTES FEMALE PIPE THREAD  
BFW DENOTES BEVELED FOR WELDING  
GVD DENOTES GROOVED  
FLG DENOTES FLANGE
  - +UNIT WEIGHT DOES NOT INCLUDE ACCESSORIES (SEE ACCESSORY DRAWINGS)
  - 3/4" [19MM] DIA. MOUNTING HOLES. REFER TO RECOMMENDED STEEL SUPPORT DRAWING
  - DIMENSIONS LISTED AS FOLLOWS:  
ENGLISH FT-IN  
[METRIC] [mm]
  - MAKE-UP WATER PRESSURE  
20 psi MIN [137 kPa], 50 psi MAX [344 kPa]

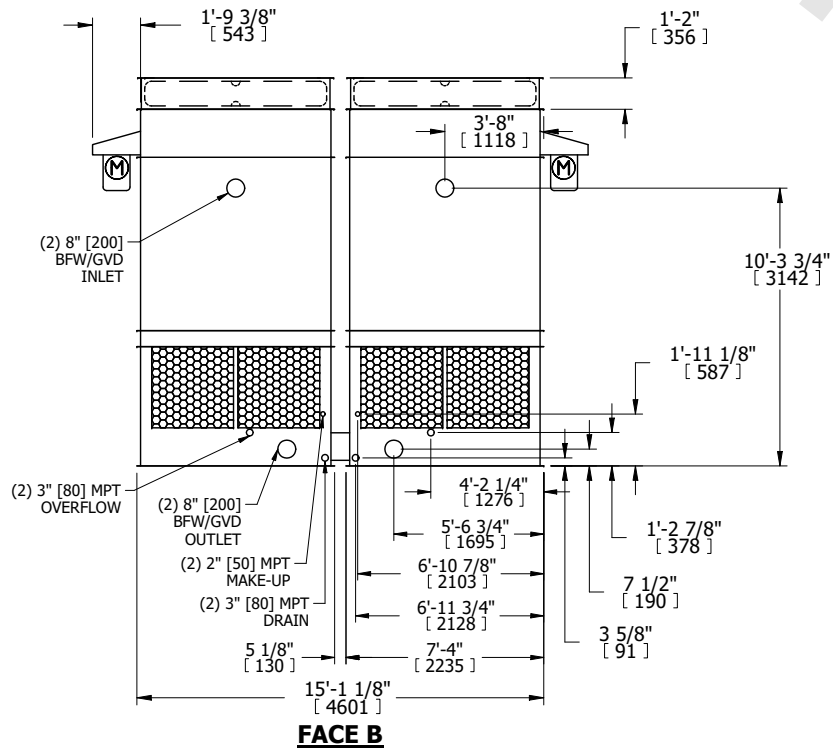
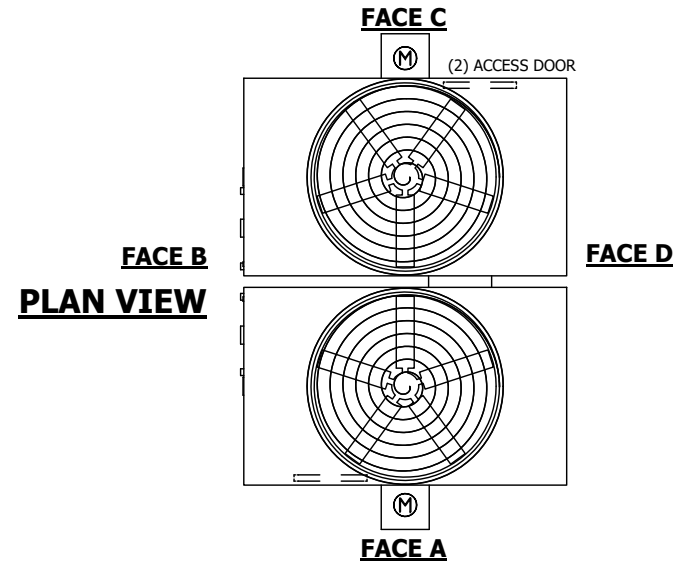

|                 |                       |                  |                       |                         |                      |                          |   |           |     |
|-----------------|-----------------------|------------------|-----------------------|-------------------------|----------------------|--------------------------|---|-----------|-----|
| SHIPPING WEIGHT | 11040 lbs+ [5010] kg+ | OPERATING WEIGHT | 16010 lbs+ [7265] kg+ | HEAVIEST SECTION WEIGHT | 3770 lbs+ [1715] kg+ | NO. OF SHIPPING SECTIONS | 4 | DRAWN BY: | MBG |
|-----------------|-----------------------|------------------|-----------------------|-------------------------|----------------------|--------------------------|---|-----------|-----|