

UNIT	COOLING TOWER	
MODEL #	AT 214-3J18	SCALE NTS

# EVAPCO, INC.

DWG. #	CT4C141836-DRA-ST	REV.	-
SERIAL #		DATE	4/11/2026

- NOTES:
- (M)- FAN MOTOR LOCATION
  - HEAVIEST SECTION IS FAN/CASING SECTION
  - MPT DENOTES MALE PIPE THREAD  
FPT DENOTES FEMALE PIPE THREAD  
BFW DENOTES BEVELED FOR WELDING  
GVD DENOTES GROOVED  
FLG DENOTES FLANGE
  - +UNIT WEIGHT DOES NOT INCLUDE ACCESSORIES (SEE ACCESSORY DRAWINGS)
  - 3/4" [19MM] DIA. MOUNTING HOLES. REFER TO RECOMMENDED STEEL SUPPORT DRAWING
  - DIMENSIONS LISTED AS FOLLOWS:  
ENGLISH FT-IN  
[METRIC] [mm]
  - MAKE-UP WATER PRESSURE  
20 psi MIN [137 kPa], 50 psi MAX [344 kPa]

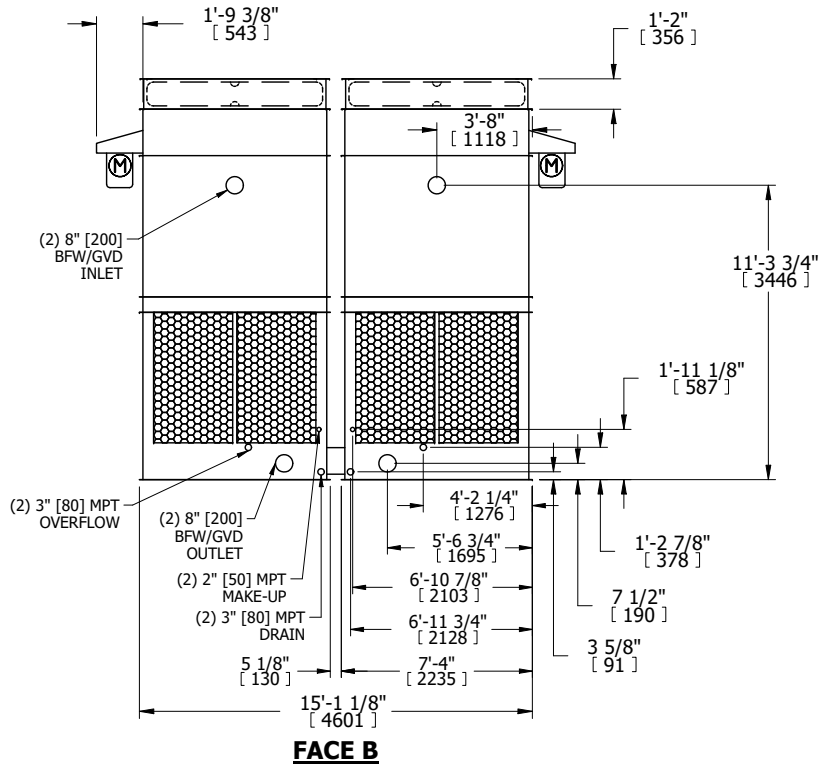
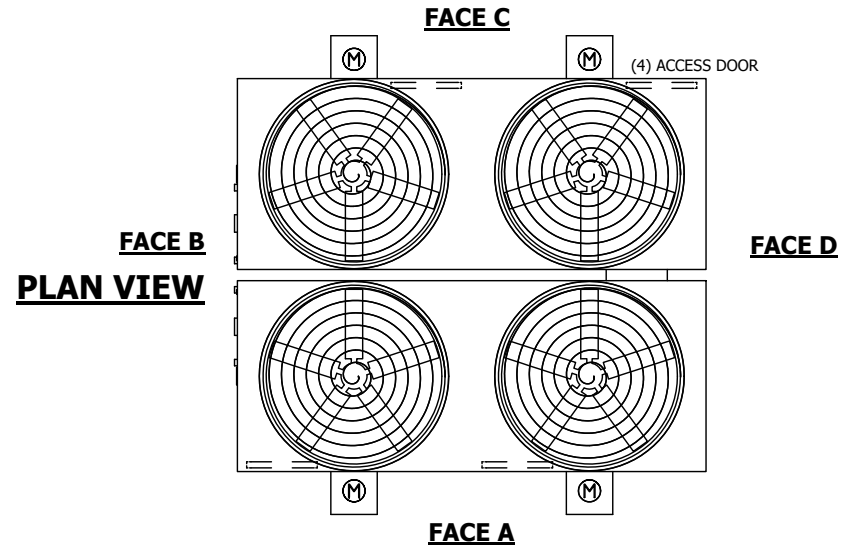

SHIPPING WEIGHT	17140 lbs+ [7775] kg+	OPERATING WEIGHT	24740 lbs+ [11225] kg+	HEAVIEST SECTION WEIGHT	5560 lbs+ [2525] kg+	NO. OF SHIPPING SECTIONS	4	DRAWN BY:	MBG
-----------------	-----------------------	------------------	------------------------	-------------------------	----------------------	--------------------------	---	-----------	-----