

# EVAPCO, INC.



UNIT	MODEL #	SCALE	DWG. #	REV.	DATE	SERIAL #
<b>COOLING TOWER</b>	AT 310-4N54	N.T.S.	T3TM5448-DRC-ST	-	7/2/2026	

- NOTES:
- (M)- FAN MOTOR LOCATION
  - HEAVIEST SECTION IS UPPER SECTION
  - MPT DENOTES MALE PIPE THREAD  
FPT DENOTES FEMALE PIPE THREAD  
BFW DENOTES BEVELED FOR WELDING
  - +UNIT WEIGHT DOES NOT INCLUDE ACCESSORIES (SEE ACCESSORY DRAWINGS)
  - MAKE-UP WATER PRESSURE  
20 psi MIN [137 kPa], 50 psi MAX [344 kPa]

**FACE 2  
PLAN VIEW**

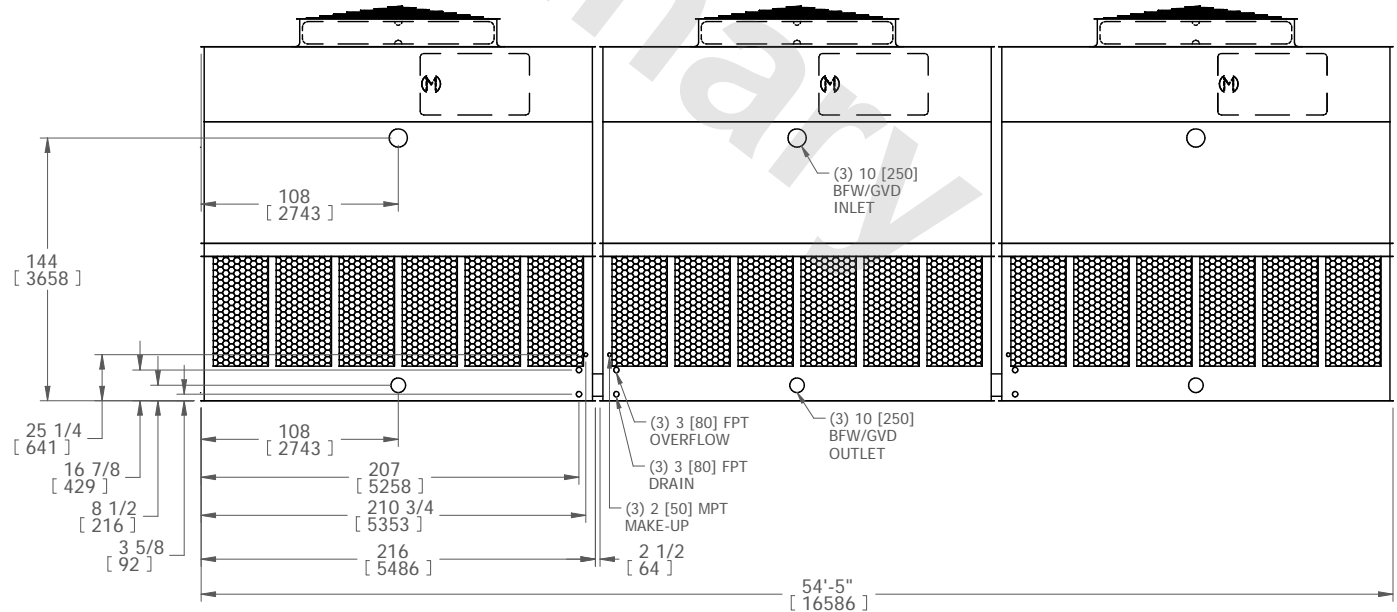
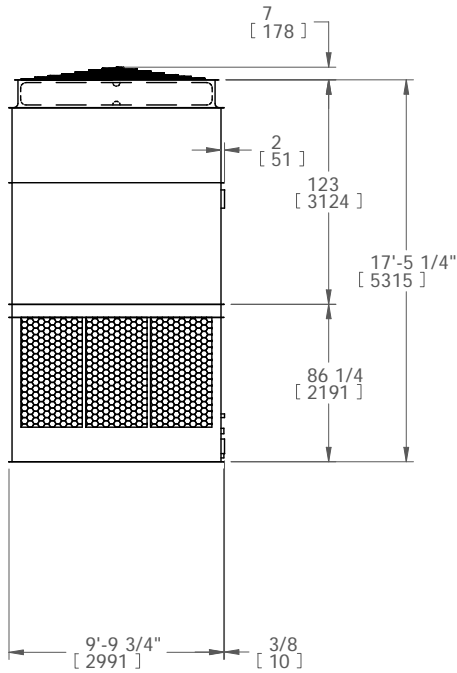

SHIPPING WEIGHT	32430 lbs+ [14710] kg+	OPERATING WEIGHT	57650 lbs+ [26150] kg+	HEAVIEST SECTION WEIGHT	7480 lbs+ [3393] kg+	NO. OF SHIPPING SECTIONS	6
-----------------	------------------------	------------------	------------------------	-------------------------	----------------------	--------------------------	---