

UNIT	COOLING TOWER	
MODEL #	AT 114-5K26	SCALE NTS

# EVAPCO, INC.

DWG. #	T4142660-DRA-ST	REV.	-
SERIAL #		DATE	4/25/2026

- NOTES:
- (M)- FAN MOTOR LOCATION
  - HEAVIEST SECTION IS UPPER SECTION
  - MPT DENOTES MALE PIPE THREAD  
FPT DENOTES FEMALE PIPE THREAD  
BFW DENOTES BEVELED FOR WELDING  
GVD DENOTES GROOVED  
FLG DENOTES FLANGE  
PE DENOTES PLAIN END
  - +UNIT WEIGHT DOES NOT INCLUDE ACCESSORIES (SEE ACCESSORY DRAWINGS)
  - MAKE-UP WATER PRESSURE  
20 psi MIN [137 kPa], 50 psi MAX [344 kPa]
  - 3/4" [19MM] DIA. MOUNTING HOLES.  
REFER TO RECOMMENDED STEEL SUPPORT DRAWING
  - DIMENSIONS LISTED AS FOLLOWS:  
ENGLISH FT-IN  
[METRIC] [mm]

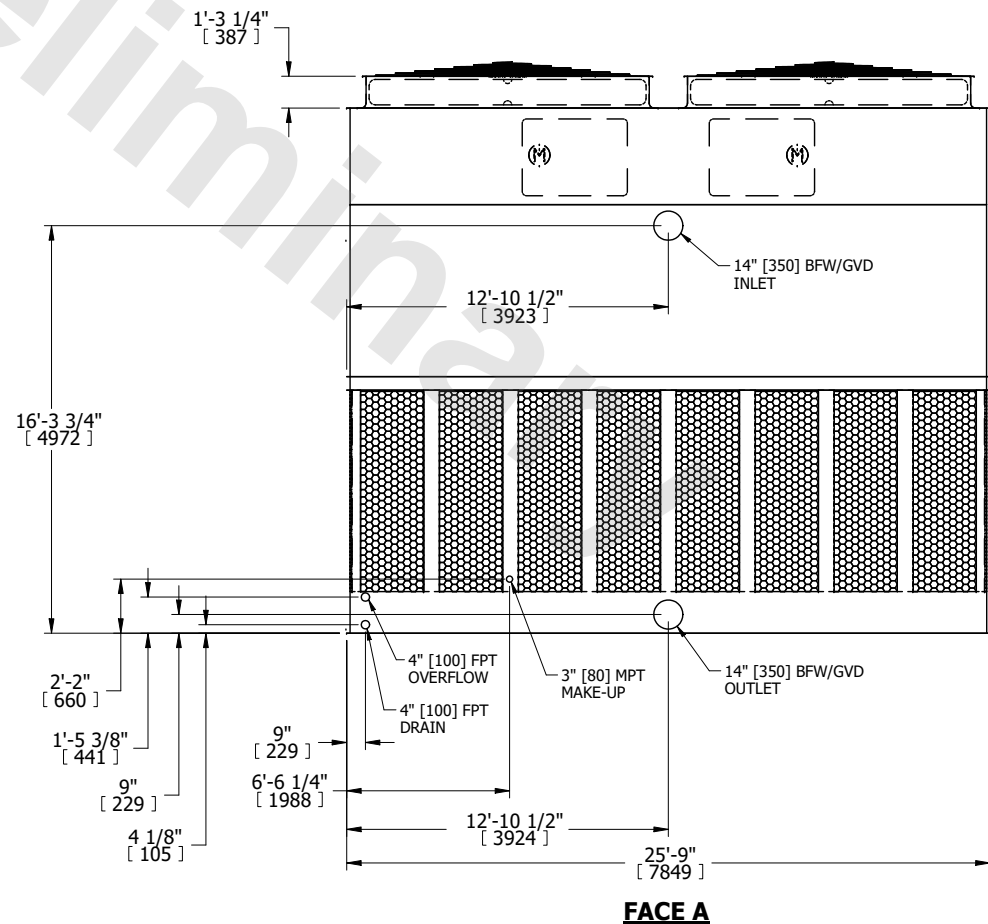
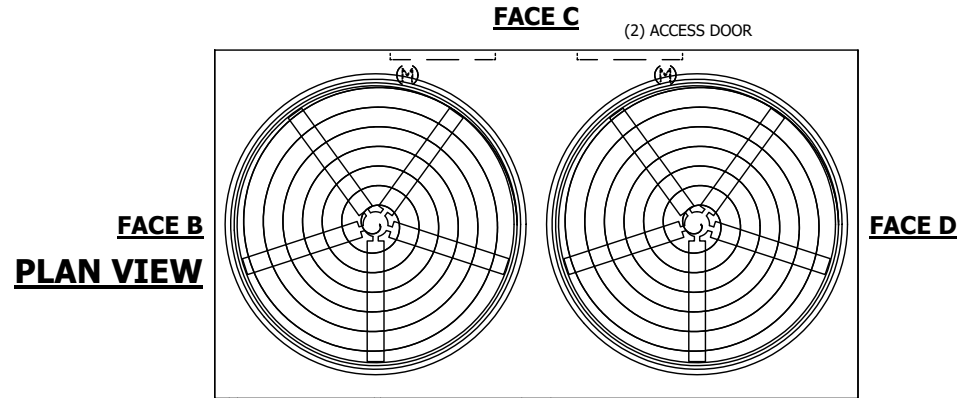

SHIPPING WEIGHT	24640 lbs+ [11180] kg+	OPERATING WEIGHT	41470 lbs+ [18815] kg+	HEAVIEST SECTION WEIGHT	17660 lbs+ [8015] kg+	NO. OF SHIPPING SECTIONS	2	DRAWN BY:	MER
-----------------	------------------------	------------------	------------------------	-------------------------	-----------------------	--------------------------	---	-----------	-----