

|         |               |           |
|---------|---------------|-----------|
| UNIT    | COOLING TOWER |           |
| MODEL # | AT 424-2J28   | SCALE NTS |

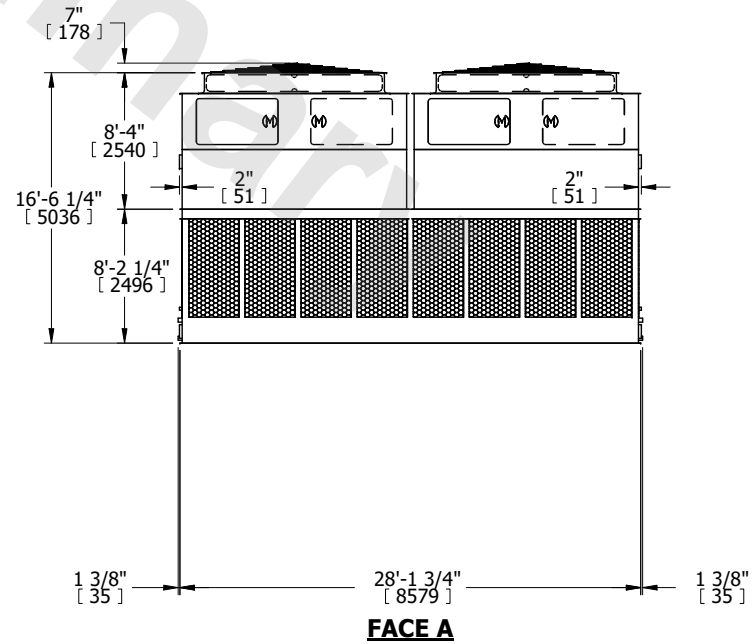

|          |                 |      |           |
|----------|-----------------|------|-----------|
| DWG. #   | T3242824-DRH-ST | REV. | -         |
| SERIAL # |                 | DATE | 4/23/2026 |

- NOTES:
- (M)- FAN MOTOR LOCATION
  - HEAVIEST SECTION IS UPPER SECTION
  - MPT DENOTES MALE PIPE THREAD  
FPT DENOTES FEMALE PIPE THREAD  
BFW DENOTES BEVELED FOR WELDING  
GVD DENOTES GROOVED  
FLG DENOTES FLANGE
  - +UNIT WEIGHT DOES NOT INCLUDE ACCESSORIES (SEE ACCESSORY DRAWINGS)
  - MAKE-UP WATER PRESSURE  
20 psi MIN [137 kPa], 50 psi MAX [344 kPa]
  - 3/4" [19MM] DIA. MOUNTING HOLES. REFER TO RECOMMENDED STEEL SUPPORT DRAWING.
  - DIMENSIONS LISTED AS FOLLOWS:  
ENGLISH FT-IN  
[METRIC] [mm]

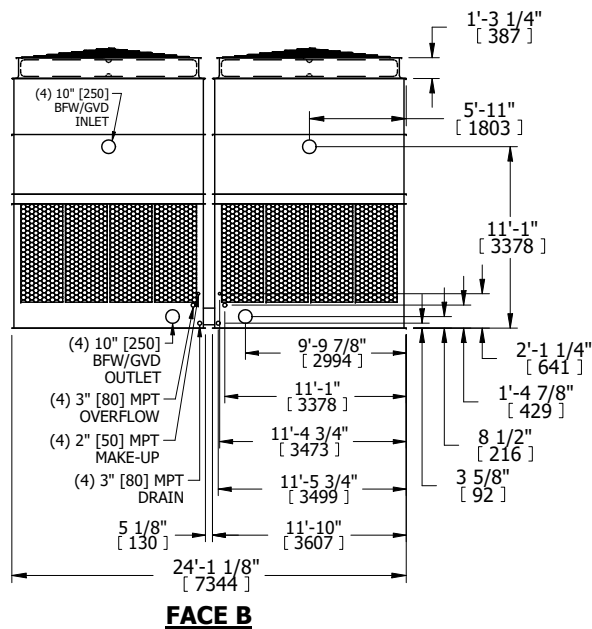
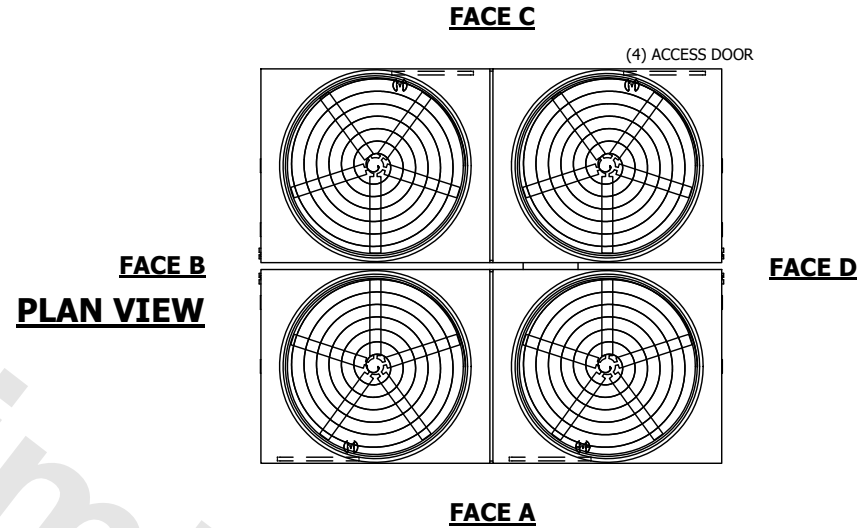

|                 |                        |                  |                        |                         |                      |                          |   |           |     |
|-----------------|------------------------|------------------|------------------------|-------------------------|----------------------|--------------------------|---|-----------|-----|
| SHIPPING WEIGHT | 34820 lbs+ [15795] kg+ | OPERATING WEIGHT | 63720 lbs+ [28905] kg+ | HEAVIEST SECTION WEIGHT | 6550 lbs+ [2975] kg+ | NO. OF SHIPPING SECTIONS | 6 | DRAWN BY: | JLG |
|-----------------|------------------------|------------------|------------------------|-------------------------|----------------------|--------------------------|---|-----------|-----|