

EVAPCO, INC.



UNIT COOLING TOWER	MODEL # AT 420-2L36	SCALE N.T.S.	DWG. # T36M3624-DRE-ST	REV. -	DATE 4/25/2026	SERIAL #
------------------------------	------------------------	-----------------	---------------------------	-----------	-------------------	----------

- NOTES:
- (M)- FAN MOTOR LOCATION
 - HEAVIEST SECTION IS UPPER SECTION
 - MPT DENOTES MALE PIPE THREAD
FPT DENOTES FEMALE PIPE THREAD
BFW DENOTES BEVELED FOR WELDING
 - +UNIT WEIGHT DOES NOT INCLUDE ACCESSORIES (SEE ACCESSORY DRAWINGS)
 - MAKE-UP WATER PRESSURE
20 psi MIN [137 kPa], 50 psi MAX [344 kPa]

**FACE 2
PLAN VIEW**

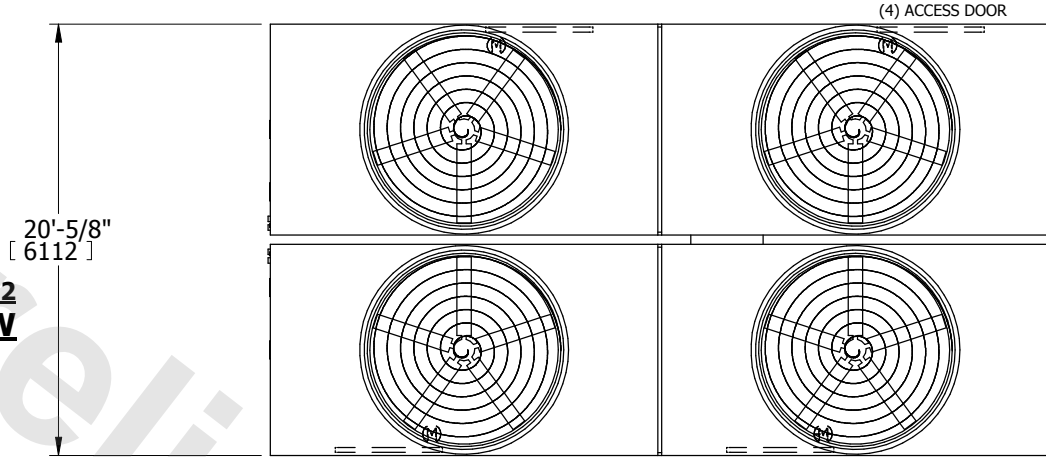

FACE 1

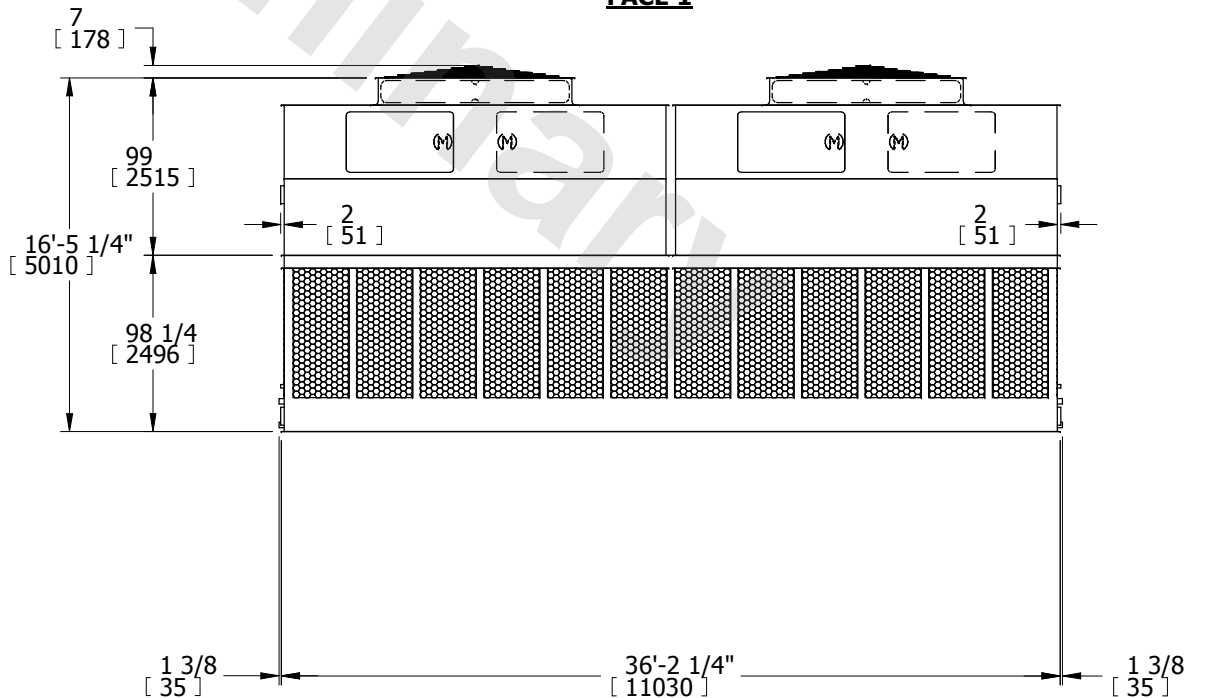

FACE 2

FACE 1

SHIPPING WEIGHT 36380 lbs+ [16502] kg+	OPERATING WEIGHT 70340 lbs+ [31906] kg+	HEAVIEST SECTION WEIGHT 6370 lbs+ [2889] kg+	NO. OF SHIPPING SECTIONS 6
---	--	---	-------------------------------