

UNIT	CLOSED CIRCUIT COOLER
MODEL #	ESW4 14-25L22-AP
SCALE	NTS

EVAPCO, INC.

DWG. #	WX414222410-DRB-ST	REV	-
SERIAL #		DATE:	4/23/2026

- NOTES:
- (M)- FAN MOTOR LOCATION
 - HEAVIEST SECTION IS COIL SECTION
 - MPT DENOTES MALE PIPE THREAD
FPT DENOTES FEMALE PIPE THREAD
BFW DENOTES BEVELED FOR WELDING
GVD DENOTES GROOVED
FLG DENOTES FLANGE
 - +UNIT WEIGHT DOES NOT INCLUDE ACCESSORIES (SEE ACCESSORY DRAWINGS)
 - 3/4" [19MM] DIA. MOUNTING HOLES. REFER TO RECOMMENDED STEEL SUPPORT DRAWING
 - MAKE-UP WATER PRESSURE
20 psi MIN [137 kPa], 50 psi MAX [344 kPa]
 - DIMENSIONS LISTED AS FOLLOWS:
ENGLISH FT-IN
[METRIC] [mm]
 - * - APPROXIMATE DIMENSIONS DO NOT USE FOR PRE-FABRICATION OF CONNECTING PIPING

**FACE B
PLAN VIEW**

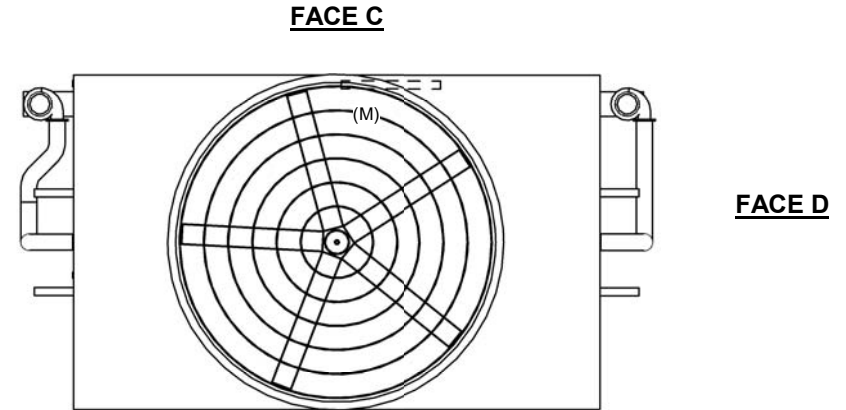

FACE A



FACE A



FACE B

MODEL NUMBER	DIMENSION A
ESW4 14-25*22-LP	2'-1 3/4"
ESW4 14-25*22-AP	2'-7 1/4"

SHIPPING WEIGHT	41540 lbs+ [18845] kg+	OPERATING WEIGHT	62160 lbs+ [28200] kg+	HEAVIEST SECTION WEIGHT	30410 lbs+ [13795] kg+	NO. OF SHIPPING SECTIONS	2	DRAWN BY:	JLG
-----------------	------------------------	------------------	------------------------	-------------------------	------------------------	--------------------------	---	-----------	-----