

|         |               |           |
|---------|---------------|-----------|
| UNIT    | COOLING TOWER |           |
| MODEL # | AT 428-4N36   | SCALE NTS |

# EVAPCO, INC.

|          |                 |       |           |
|----------|-----------------|-------|-----------|
| DWG. #   | T4283648-DRA-ST | REV   | -         |
| SERIAL # |                 | DATE: | 6/25/2026 |

**NOTES:**

- (M)- FAN MOTOR LOCATION
- HEAVIEST SECTION IS FAN/CASING SECTION
- MPT DENOTES MALE PIPE THREAD  
FPT DENOTES FEMALE PIPE THREAD  
BFW DENOTES BEVELED FOR WELDING  
GVD DENOTES GROOVED  
FLG DENOTES FLANGE
- +UNIT WEIGHT DOES NOT INCLUDE ACCESSORIES (SEE ACCESSORY DRAWINGS)
- 3/4" [19MM] DIA. MOUNTING HOLES. REFER TO RECOMMENDED STEEL SUPPORT DRAWING
- DIMENSIONS LISTED AS FOLLOWS:  
ENGLISH FT-IN  
[METRIC] [mm]
- MAKE-UP WATER PRESSURE  
20 psi MIN [137 kPa], 50 psi MAX [344 kPa]
- PAN FLUME BOX EQUALIZERS SUPPLIED BY EVAPCO PAN EQUALIZER PIPING IS SUPPLIED BY OTHERS.
- PAN EQUALIZER NIPPLE IS 11'-10 3/8" [3616] OFF EACH STEP SIDE.

**FACE C**



**FACE B  
PLAN VIEW**

**FACE D**



**FACE B**

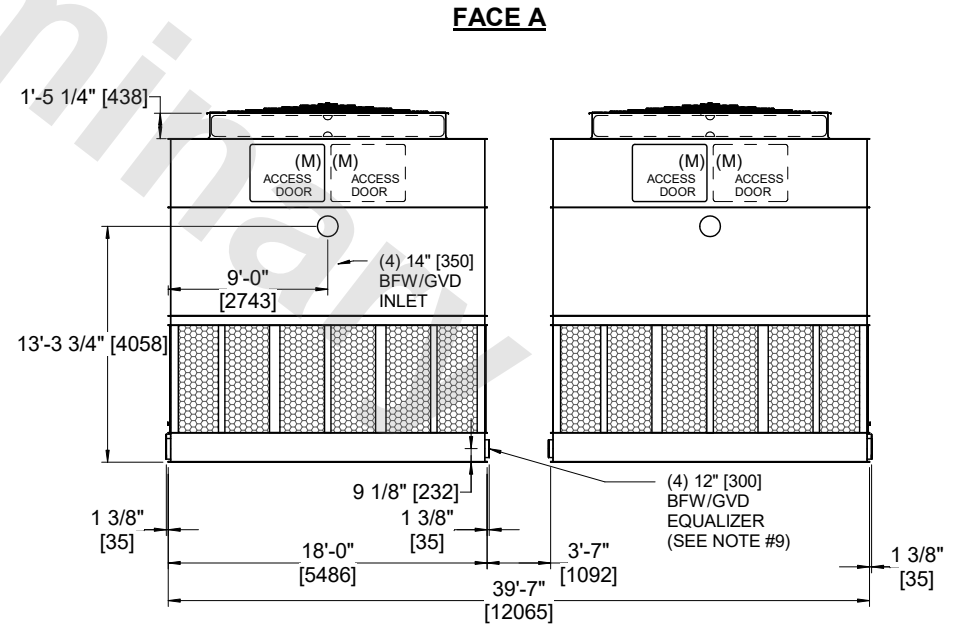

**FACE A**

|                 |                        |                  |                         |                         |                       |                          |   |           |     |
|-----------------|------------------------|------------------|-------------------------|-------------------------|-----------------------|--------------------------|---|-----------|-----|
| SHIPPING WEIGHT | 69840 lbs+ [31680] kg+ | OPERATING WEIGHT | 108680 lbs+ [49300] kg+ | HEAVIEST SECTION WEIGHT | 12370 lbs+ [5615] kg+ | NO. OF SHIPPING SECTIONS | 8 | DRAWN BY: | TRS |
|-----------------|------------------------|------------------|-------------------------|-------------------------|-----------------------|--------------------------|---|-----------|-----|