

UNIT	COOLING TOWER	
MODEL #	AT 214-4N36	SCALE NTS

EVAPCO, INC.

DWG. #	T4143648-DRA-ST	REV	-
SERIAL #		DATE:	5/7/2026

- NOTES:**
- (M)- FAN MOTOR LOCATION
 - HEAVIEST SECTION IS FAN/CASING SECTION
 - MPT DENOTES MALE PIPE THREAD
FPT DENOTES FEMALE PIPE THREAD
BFW DENOTES BEVELED FOR WELDING
GVD DENOTES GROOVED
FLG DENOTES FLANGE
 - +UNIT WEIGHT DOES NOT INCLUDE ACCESSORIES (SEE ACCESSORY DRAWINGS)
 - 3/4" [19MM] DIA. MOUNTING HOLES. REFER TO RECOMMENDED STEEL SUPPORT DRAWING
 - DIMENSIONS LISTED AS FOLLOWS:
ENGLISH FT-IN
[METRIC] [mm]
 - MAKE-UP WATER PRESSURE
20 psi MIN [137 kPa], 50 psi MAX [344 kPa]

FACE C

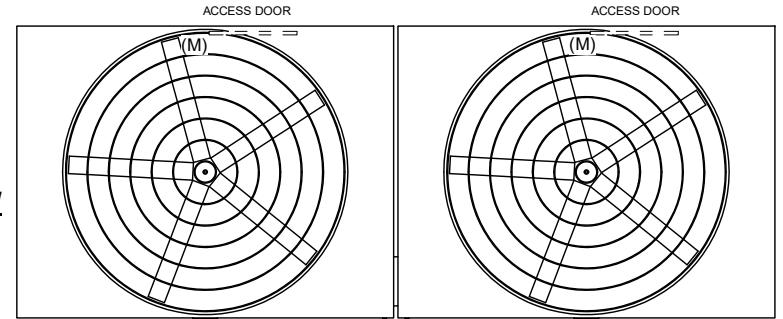

**FACE B
PLAN VIEW**

FACE D

FACE A



FACE B



FACE A

SHIPPING WEIGHT	34880 lbs+ [15825] kg+	OPERATING WEIGHT	54300 lbs+ [24635] kg+	HEAVIEST SECTION WEIGHT	12370 lbs+ [5615] kg+	NO. OF SHIPPING SECTIONS	4	DRAWN BY:	TRS
-----------------	------------------------	------------------	------------------------	-------------------------	-----------------------	--------------------------	---	-----------	-----