

| | | |
|---------|---------------|-----------|
| UNIT | COOLING TOWER | |
| MODEL # | AT 214-4K36 | SCALE NTS |

EVAPCO, INC.



| | | | |
|----------|-----------------|-------|----------|
| DWG. # | T4143648-DRA-ST | REV | - |
| SERIAL # | | DATE: | 5/7/2026 |

NOTES:

- (M)- FAN MOTOR LOCATION
- HEAVIEST SECTION IS FAN/CASING SECTION
- MPT DENOTES MALE PIPE THREAD
FPT DENOTES FEMALE PIPE THREAD
BFW DENOTES BEVELED FOR WELDING
GVD DENOTES GROOVED
FLG DENOTES FLANGE
- +UNIT WEIGHT DOES NOT INCLUDE ACCESSORIES (SEE ACCESSORY DRAWINGS)
- 3/4" [19MM] DIA. MOUNTING HOLES. REFER TO RECOMMENDED STEEL SUPPORT DRAWING
- DIMENSIONS LISTED AS FOLLOWS:
ENGLISH FT-IN
[METRIC] [mm]
- MAKE-UP WATER PRESSURE
20 psi MIN [137 kPa], 50 psi MAX [344 kPa]

FACE C

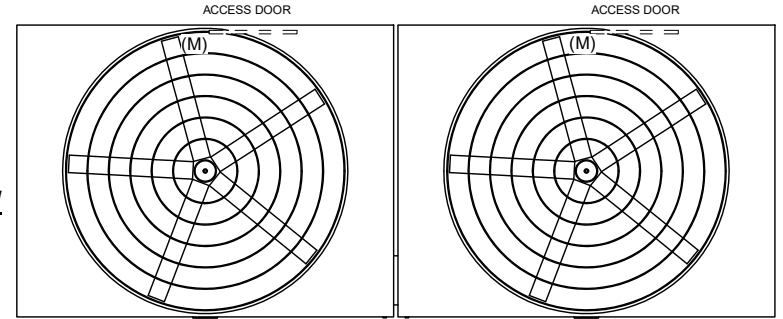

**FACE B
PLAN VIEW**

FACE D

FACE A

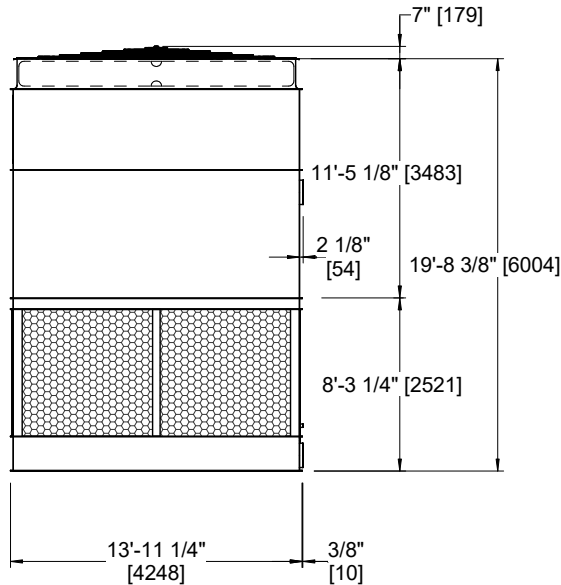

FACE B

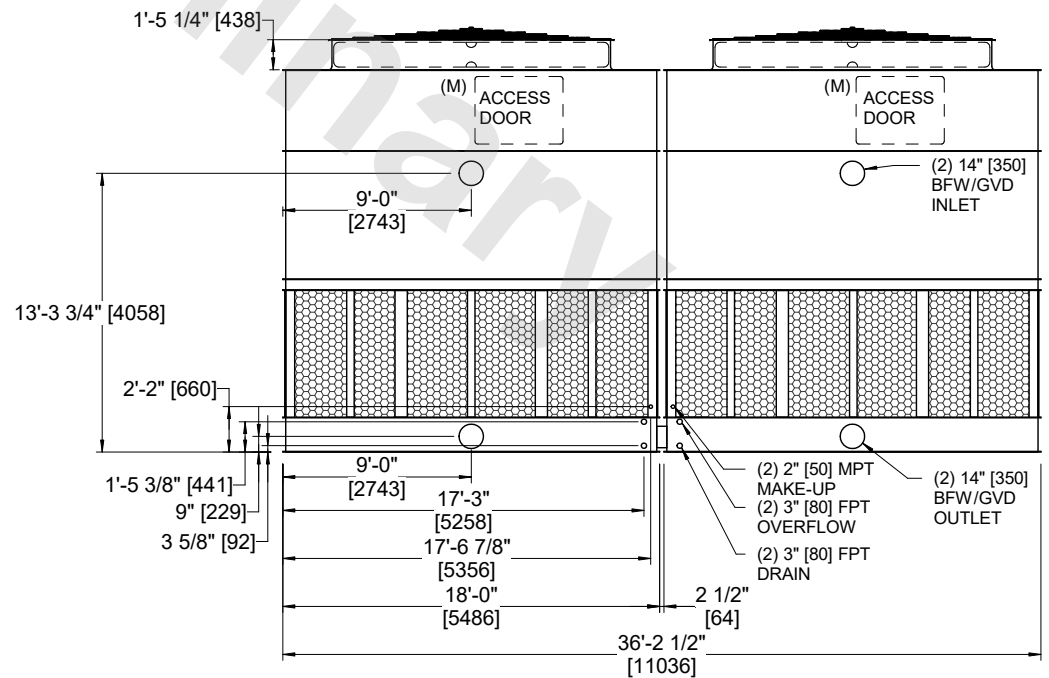

FACE A

| | | | | | | | | | |
|-----------------|------------------------|------------------|------------------------|-------------------------|-----------------------|--------------------------|---|-----------|-----|
| SHIPPING WEIGHT | 34440 lbs+ [15625] kg+ | OPERATING WEIGHT | 53860 lbs+ [24435] kg+ | HEAVIEST SECTION WEIGHT | 12150 lbs+ [5515] kg+ | NO. OF SHIPPING SECTIONS | 4 | DRAWN BY: | TRS |
|-----------------|------------------------|------------------|------------------------|-------------------------|-----------------------|--------------------------|---|-----------|-----|