

CONFIDENTIAL

This document is the property of Evapco, Inc. It should not be copied or disclosed without prior written authorization.

CUSTOMER	MODEL # U-SSTWE1-9S64F0075F3KA	SCALE N.T.S.	DWG. # USSTW1-SE-8	REV. 0	DATE 10/15/2025
----------	--------------------------------	--------------	--------------------	--------	-----------------

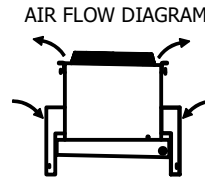
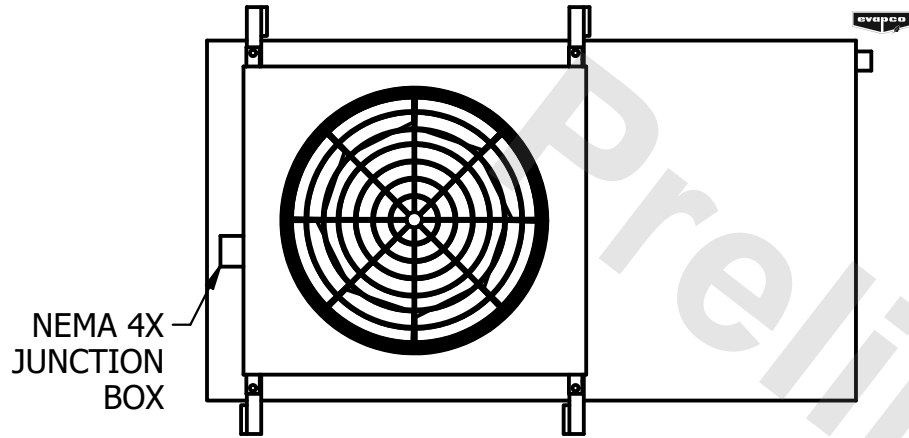

- NOTES:**
- 1) * = HANGER HOLE LOCATION.
 - 2) HANGER HOLES ARE FOR 3/4 INCH THREADED ROD.
 - 3) ALL DIMENSIONS ARE FOR REFERENCE AND SHOULD NOT BE USED FOR PREFABRICATION OF PIPING OR SUPPORTS.

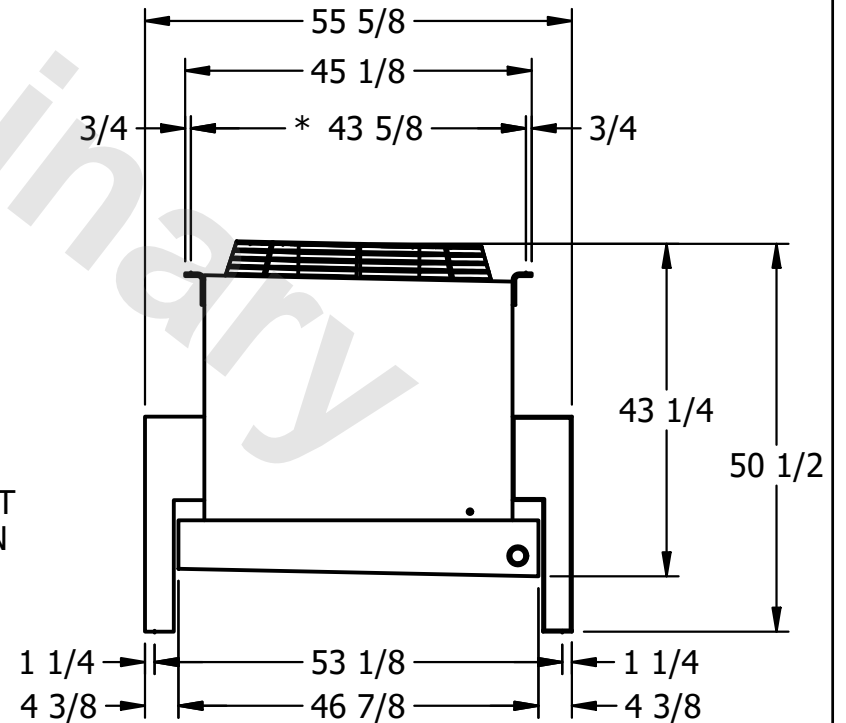
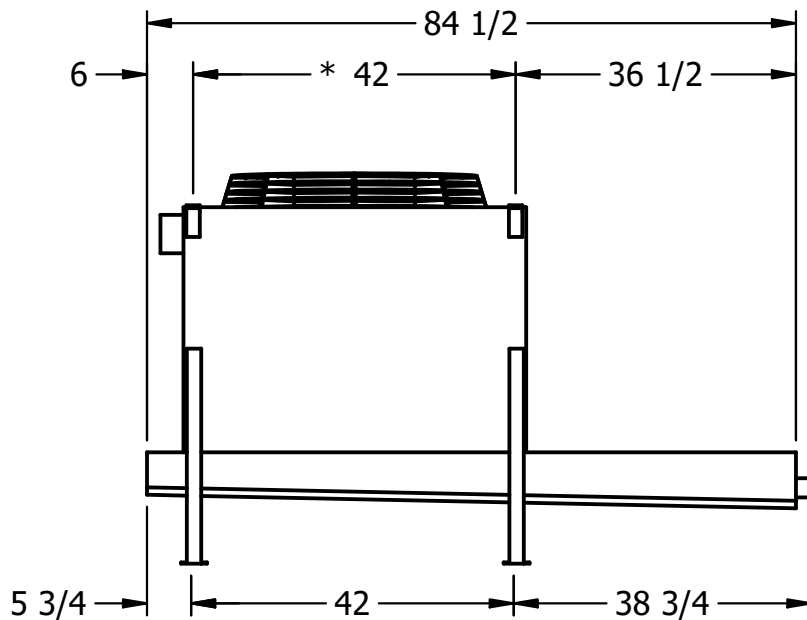

PROJECT	ROOM	SHIPPING WEIGHT 550 lbs+ [250] kg+	OPERATING WEIGHT 610 lbs+ [280] kg+
---------	------	------------------------------------	-------------------------------------