

CONFIDENTIAL

This document is the property of Evapco, Inc. It should not be copied or disclosed without prior written authorization.

| | | | | | |
|----------|---------------------------------|--------------|--------------------|--------|----------------|
| CUSTOMER | MODEL # U-SSTWE2-19S84F0100F1KA | SCALE N.T.S. | DWG. # USSTW2-SE-8 | REV. 0 | DATE 5/16/2026 |
|----------|---------------------------------|--------------|--------------------|--------|----------------|



- NOTES:**
- 1) * = HANGER HOLE LOCATION.
 - 2) HANGER HOLES ARE FOR 3/4 INCH THREADED ROD.
 - 3) ALL DIMENSIONS ARE FOR REFERENCE AND SHOULD NOT BE USED FOR PREFABRICATION OF PIPING OR SUPPORTS.

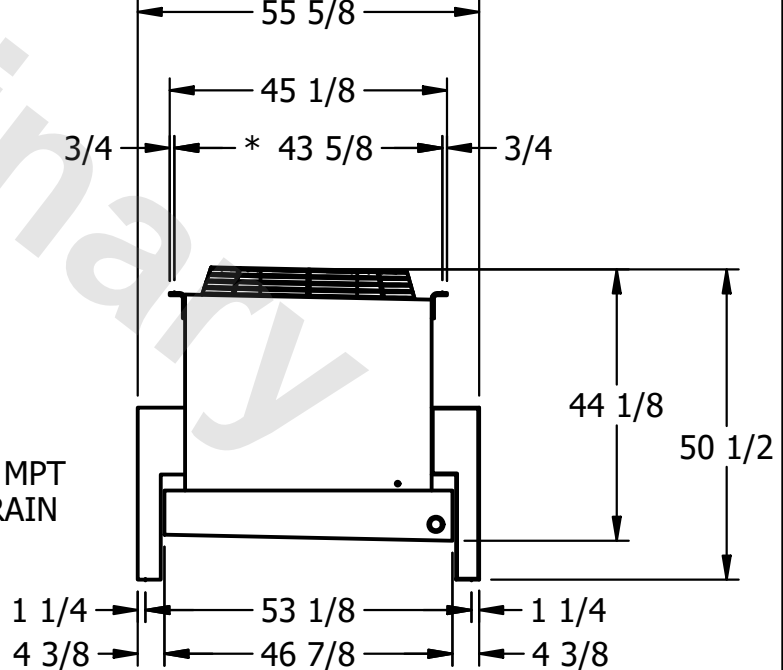
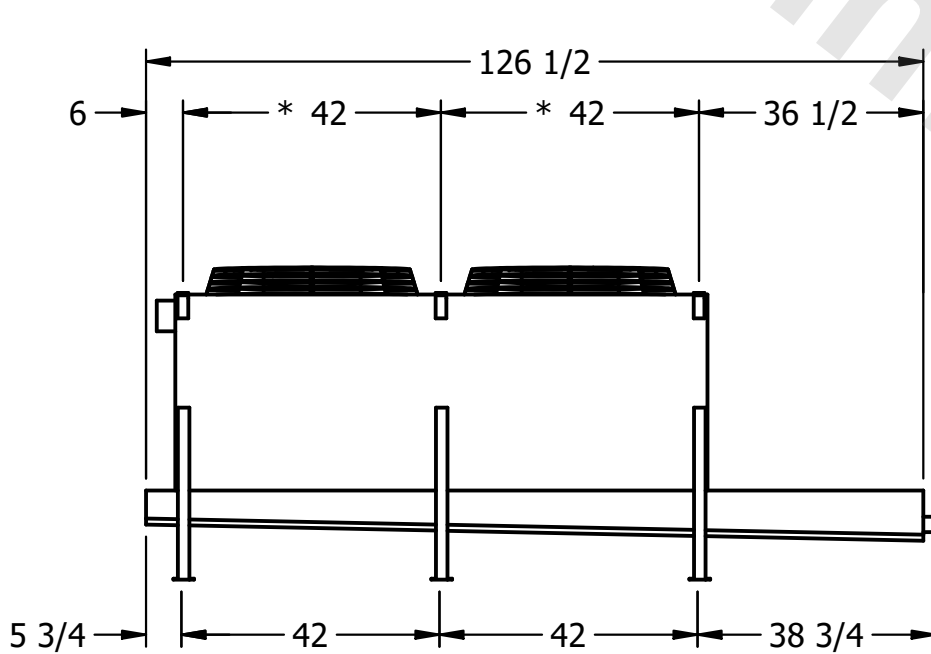

2" MPT DRAIN

| | | | |
|---------|------|-------------------------------------|--------------------------------------|
| PROJECT | ROOM | SHIPPING WEIGHT 1040 lbs+ [475] kg+ | OPERATING WEIGHT 1220 lbs+ [555] kg+ |
|---------|------|-------------------------------------|--------------------------------------|