

**CONFIDENTIAL**

This document is the property of Evapco, Inc. It should not be copied or disclosed without prior written authorization.

CUSTOMER	MODEL # U-SSTME3-4284H0150F1LA	SCALE N.T.S.	DWG. # USSTM3-SE-24	REV. 0	DATE 4/28/2026
----------	--------------------------------	--------------	---------------------	--------	----------------

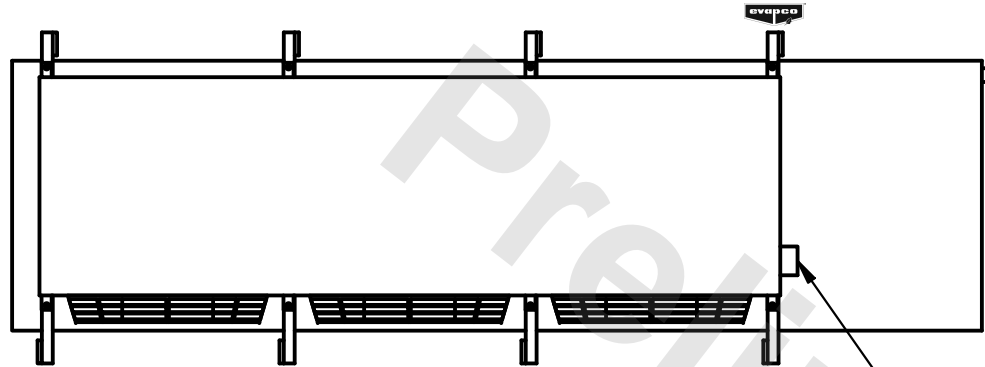

**NOTES:**

- 1) \* = HANGER HOLE LOCATION.
- 2) RIGHT HAND MODEL SHOWN.
- 3) HANGER HOLES ARE FOR 3/4 INCH THREADED ROD.
- 4) ALL DIMENSIONS ARE FOR REFERENCE AND SHOULD NOT BE USED FOR PREFABRICATION OF PIPING OR SUPPORTS.

NEMA 4X  
JUNCTION BOX

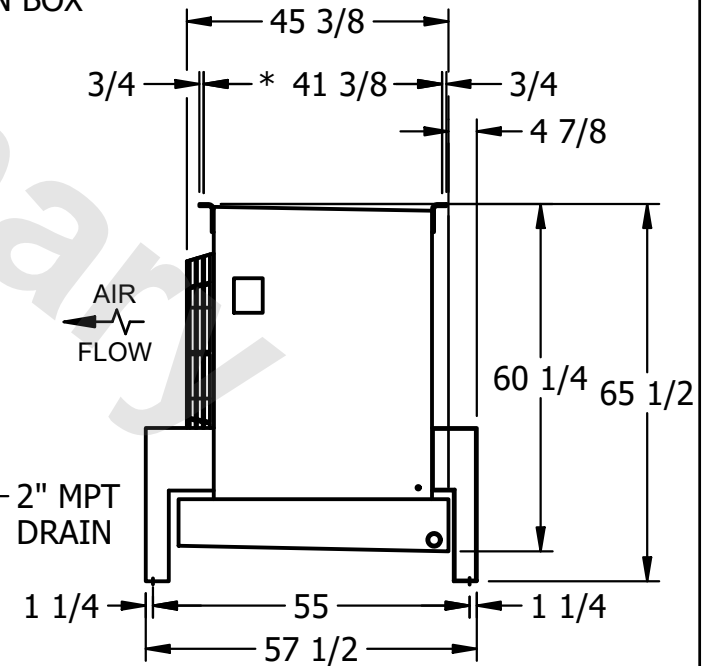
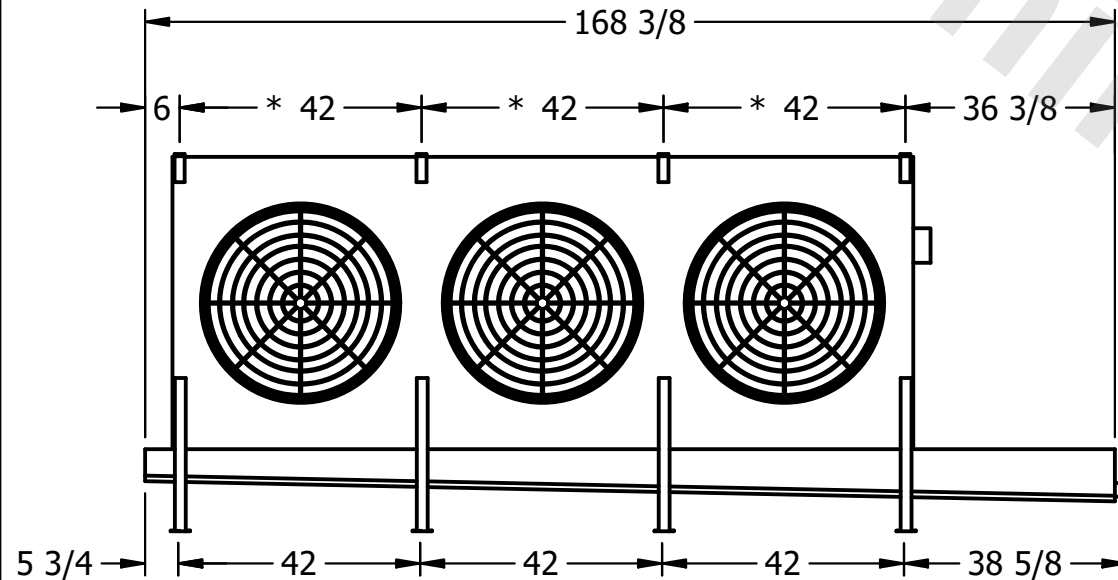

PROJECT	ROOM	SHIPPING WEIGHT 2330 lbs+ [1060] kg+	OPERATING WEIGHT 2730 lbs+ [1240] kg+
---------	------	--------------------------------------	---------------------------------------