

CONFIDENTIAL

This document is the property of Evapco, Inc. It should not be copied or disclosed without prior written authorization.

| | | | | | |
|----------|-------------------------------|--------------|------------------------|--------|---------------|
| CUSTOMER | MODEL # U-SSTME1-983F0033F1KA | SCALE N.T.S. | DWG. # USSTM1-SE-16,18 | REV. 0 | DATE 6/4/2026 |
|----------|-------------------------------|--------------|------------------------|--------|---------------|



NEMA 4X
JUNCTION BOX

NOTES:

- 1) * = HANGER HOLE LOCATION.
- 2) RIGHT HAND MODEL SHOWN.
- 3) HANGER HOLES ARE FOR 3/4 INCH THREADED ROD.
- 4) ALL DIMENSIONS ARE FOR REFERENCE AND SHOULD NOT BE USED FOR PREFABRICATION OF PIPING OR SUPPORTS.



2" MPT
DRAIN

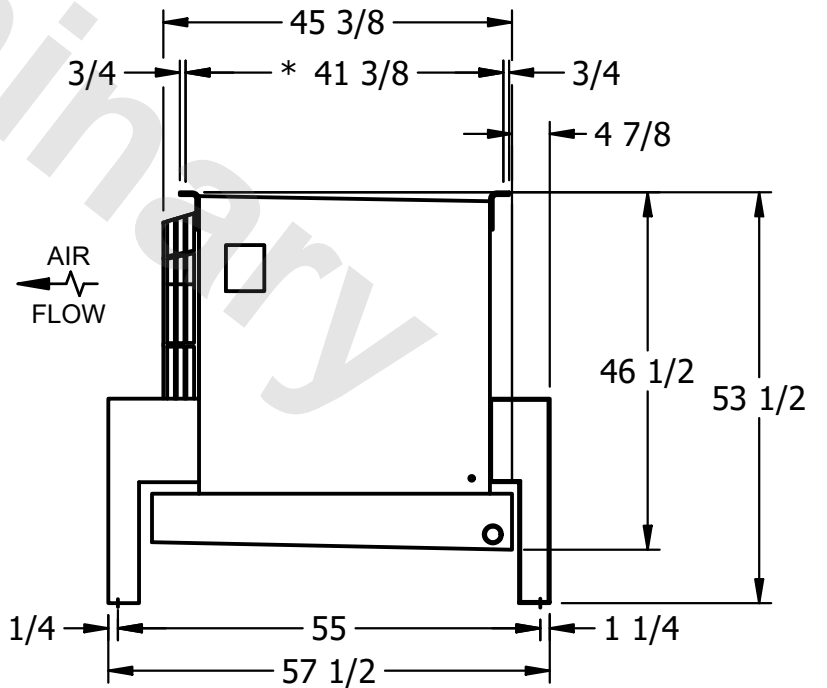

AIR
FLOW

| | | | |
|---------|------|------------------------------------|-------------------------------------|
| PROJECT | ROOM | SHIPPING WEIGHT 570 lbs+ [260] kg+ | OPERATING WEIGHT 640 lbs+ [295] kg+ |
|---------|------|------------------------------------|-------------------------------------|