

CONFIDENTIAL

This document is the property of Evapco, Inc. It should not be copied or disclosed without prior written authorization.

CUSTOMER	MODEL # U-SSTME2-2843F0033F1KA	SCALE N.T.S.	DWG. # USSTM2-SE-24	REV. 0	DATE 4/27/2026
----------	--------------------------------	--------------	---------------------	--------	----------------



NEMA 4X
JUNCTION BOX

NOTES:

- 1) * = HANGER HOLE LOCATION.
- 2) RIGHT HAND MODEL SHOWN.
- 3) HANGER HOLES ARE FOR 3/4 INCH THREADED ROD.
- 4) ALL DIMENSIONS ARE FOR REFERENCE AND SHOULD NOT BE USED FOR PREFABRICATION OF PIPING OR SUPPORTS.

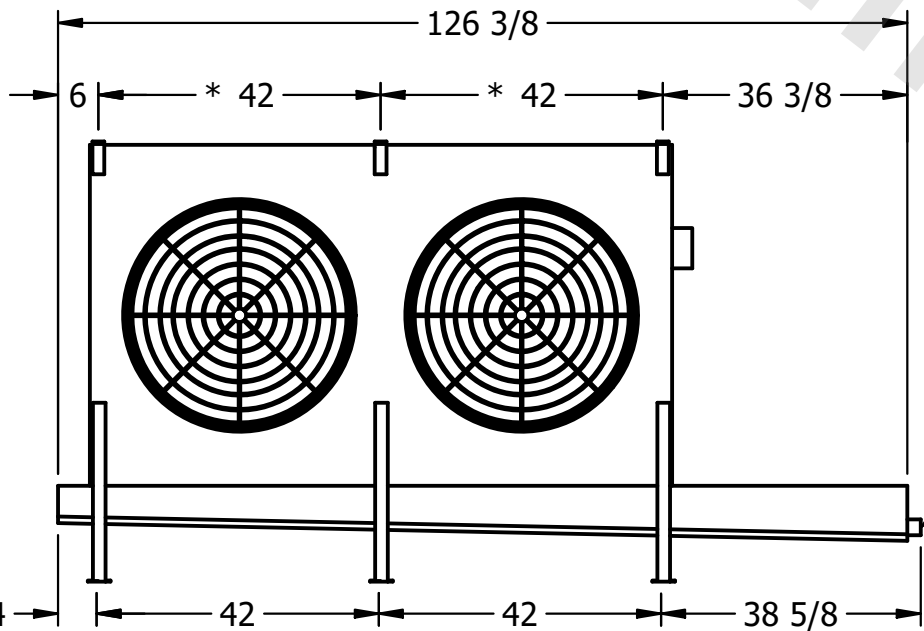

2" MPT
DRAIN



AIR
FLOW

PROJECT	ROOM	SHIPPING WEIGHT 960 lbs+ [440] kg+	OPERATING WEIGHT 1070 lbs+ [490] kg+
---------	------	------------------------------------	--------------------------------------