

CONFIDENTIAL

This document is the property of Evapco, Inc. It should not be copied or disclosed without prior written authorization.

| | | | | | |
|----------|--------------------------------|--------------|------------------------|--------|----------------|
| CUSTOMER | MODEL # U-SSTME4-3383H0050C1KA | SCALE N.T.S. | DWG. # USSTM4-SE-12,14 | REV. 0 | DATE 6/25/2026 |
|----------|--------------------------------|--------------|------------------------|--------|----------------|



NOTES:

- 1) * = HANGER HOLE LOCATION.
- 2) RIGHT HAND MODEL SHOWN.
- 3) HANGER HOLES ARE FOR 3/4 INCH THREADED ROD.
- 4) ALL DIMENSIONS ARE FOR REFERENCE AND SHOULD NOT BE USED FOR PREFABRICATION OF PIPING OR SUPPORTS.



NEMA 4X
JUNCTION BOX

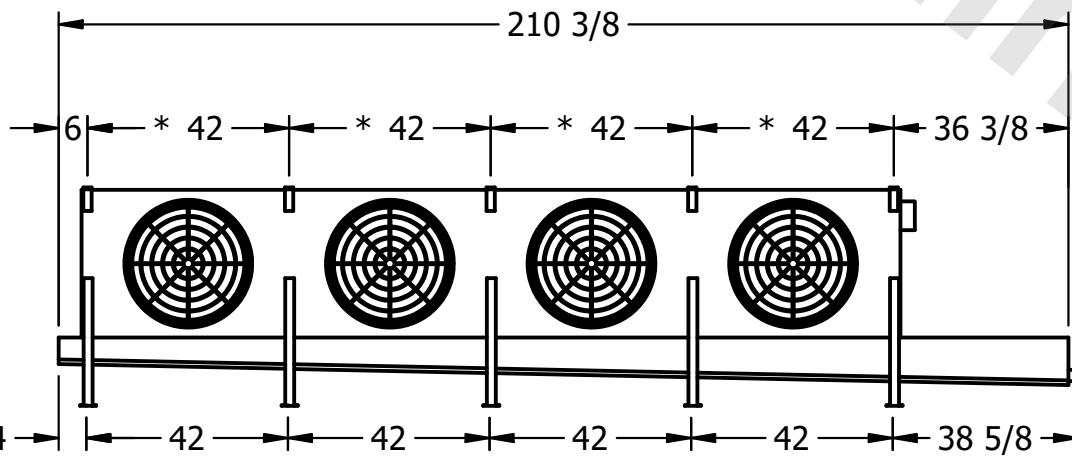

| | | | |
|---------|------|-------------------------------------|---------------------------------------|
| PROJECT | ROOM | SHIPPING WEIGHT 2170 lbs+ [985] kg+ | OPERATING WEIGHT 2430 lbs+ [1105] kg+ |
|---------|------|-------------------------------------|---------------------------------------|