

CONFIDENTIAL

This document is the property of Evapco, Inc. It should not be copied or disclosed without prior written authorization.

| | | | | | |
|----------|-------------------------------|--------------|------------------------|--------|----------------|
| CUSTOMER | MODEL # U-SSTME1-746F0050C1KA | SCALE N.T.S. | DWG. # USSTM1-SE-12,14 | REV. 0 | DATE 4/10/2026 |
|----------|-------------------------------|--------------|------------------------|--------|----------------|



NOTES:

- 1) * = HANGER HOLE LOCATION.
- 2) RIGHT HAND MODEL SHOWN.
- 3) HANGER HOLES ARE FOR 3/4 INCH THREADED ROD.
- 4) ALL DIMENSIONS ARE FOR REFERENCE AND SHOULD NOT BE USED FOR PREFABRICATION OF PIPING OR SUPPORTS.

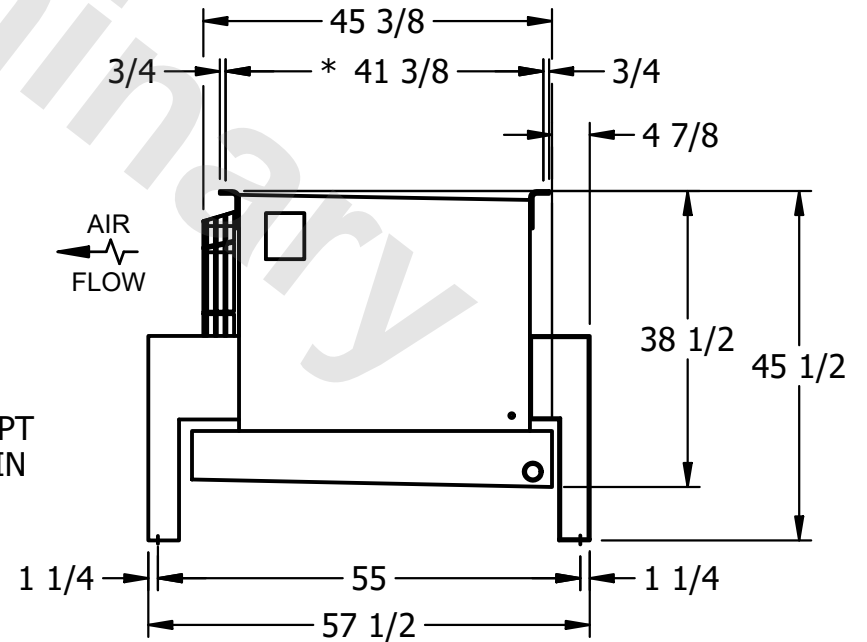

| | | | |
|---------|------|------------------------------------|-------------------------------------|
| PROJECT | ROOM | SHIPPING WEIGHT 470 lbs+ [215] kg+ | OPERATING WEIGHT 510 lbs+ [235] kg+ |
|---------|------|------------------------------------|-------------------------------------|