

CONFIDENTIAL

This document is the property of Evapco, Inc. It should not be copied or disclosed without prior written authorization.

CUSTOMER	MODEL # U-SSTME4-5684F0033F1KA	SCALE N.T.S.	DWG. # USSTM4-SE-24	REV. 0	DATE 11/23/2025
----------	--------------------------------	--------------	---------------------	--------	-----------------

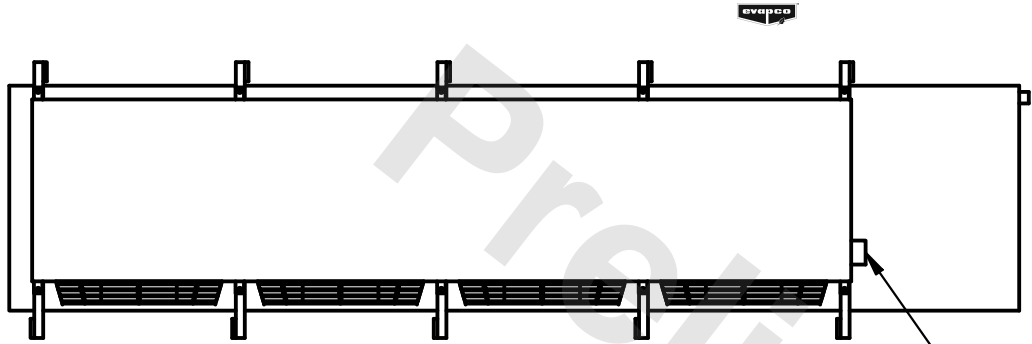

NOTES:

- 1) * = HANGER HOLE LOCATION.
- 2) RIGHT HAND MODEL SHOWN.
- 3) HANGER HOLES ARE FOR 3/4 INCH THREADED ROD.
- 4) ALL DIMENSIONS ARE FOR REFERENCE AND SHOULD NOT BE USED FOR PREFABRICATION OF PIPING OR SUPPORTS.

NEMA 4X
JUNCTION BOX

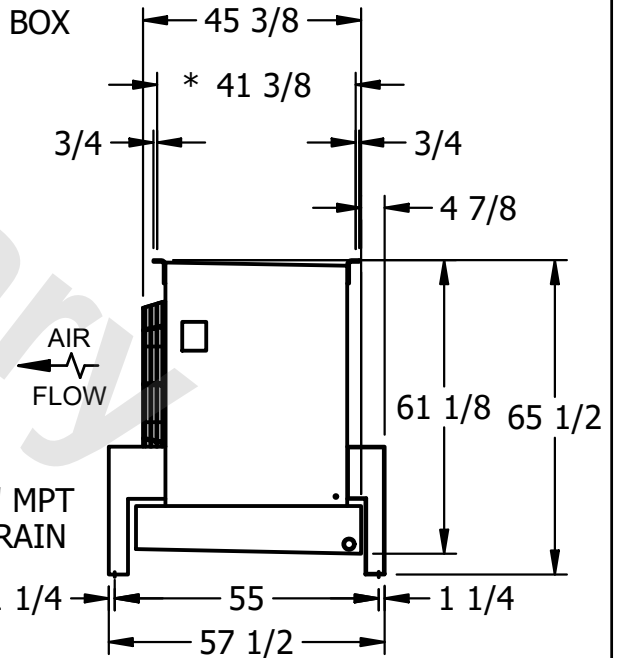
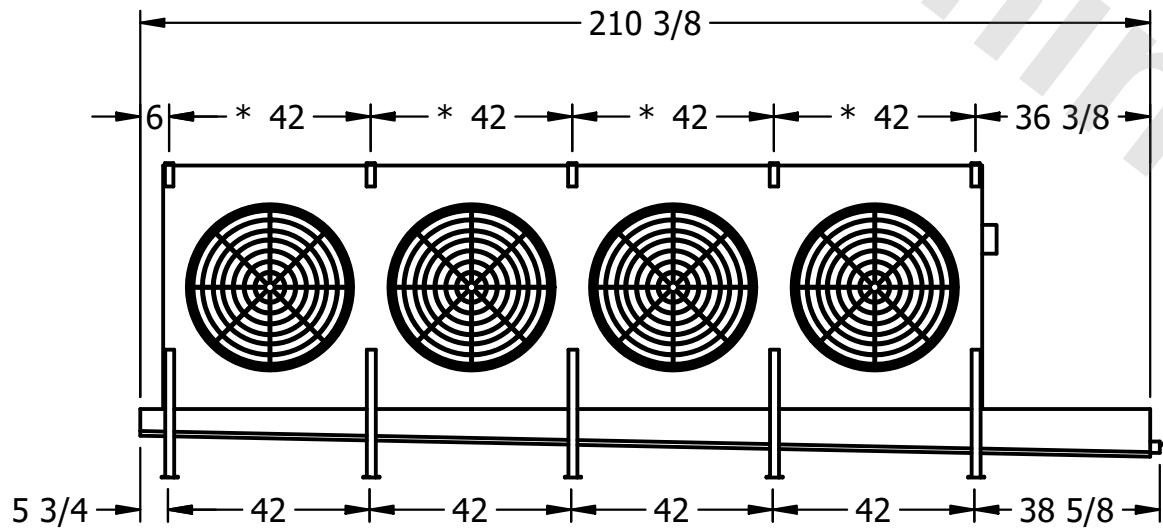

PROJECT	ROOM	SHIPPING WEIGHT 2420 lbs+ [1100] kg+	OPERATING WEIGHT 2960 lbs+ [1345] kg+
---------	------	--------------------------------------	---------------------------------------