

CONFIDENTIAL

This document is the property of Evapco, Inc. It should not be copied or disclosed without prior written authorization.

CUSTOMER	MODEL # U-SSTME3-4263F0100F1JA	SCALE N.T.S.	DWG. # USSTM3-SE-24	REV. 0	DATE 6/28/2026
----------	--------------------------------	--------------	---------------------	--------	----------------

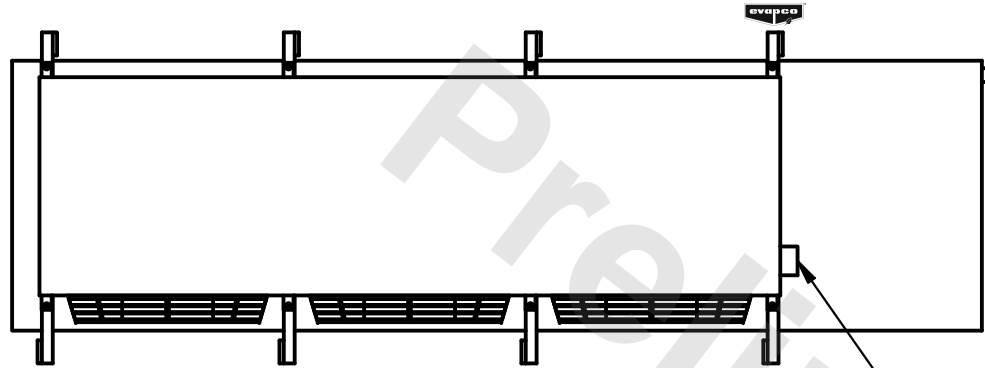

NOTES:

- 1) * = HANGER HOLE LOCATION.
- 2) RIGHT HAND MODEL SHOWN.
- 3) HANGER HOLES ARE FOR 3/4 INCH THREADED ROD.
- 4) ALL DIMENSIONS ARE FOR REFERENCE AND SHOULD NOT BE USED FOR PREFABRICATION OF PIPING OR SUPPORTS.

NEMA 4X
JUNCTION BOX



PROJECT	ROOM	SHIPPING WEIGHT 1560 lbs+ [710] kg+	OPERATING WEIGHT 1810 lbs+ [825] kg+
---------	------	-------------------------------------	--------------------------------------