

**CONFIDENTIAL**

This document is the property of Evapco, Inc. It should not be copied or disclosed without prior written authorization.

CUSTOMER	MODEL # U-SSTME2-2886H0200H1JA	SCALE N.T.S.	DWG. # USSTM2-SE-24	REV. 0	DATE 4/29/2026
----------	--------------------------------	--------------	---------------------	--------	----------------



**NOTES:**

- 1) \* = HANGER HOLE LOCATION.
- 2) RIGHT HAND MODEL SHOWN.
- 3) HANGER HOLES ARE FOR 3/4 INCH THREADED ROD.
- 4) ALL DIMENSIONS ARE FOR REFERENCE AND SHOULD NOT BE USED FOR PREFABRICATION OF PIPING OR SUPPORTS.

NEMA 4X  
JUNCTION BOX



2" MPT  
DRAIN

AIR  
FLOW

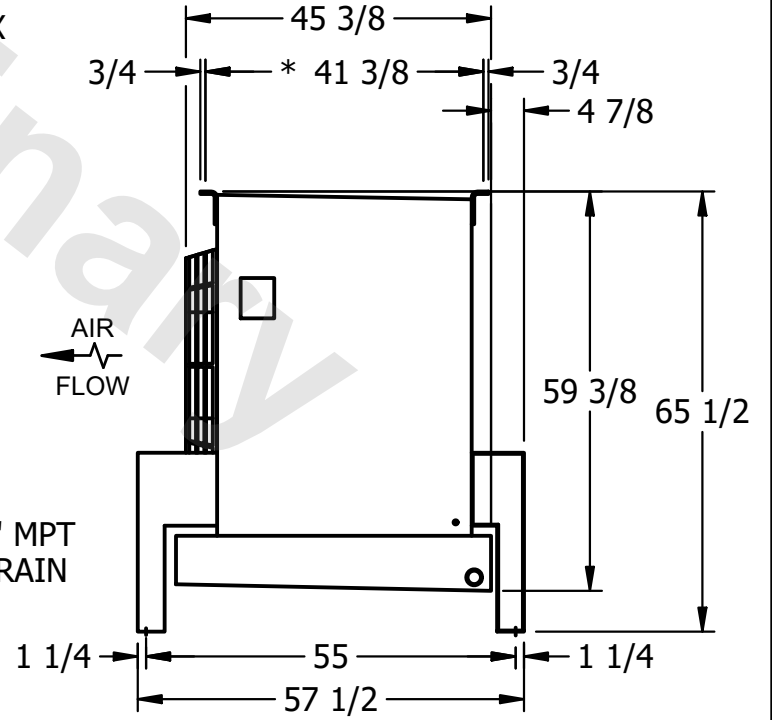

PROJECT	ROOM	SHIPPING WEIGHT 1920 lbs+ [875] kg+	OPERATING WEIGHT 2260 lbs+ [1030] kg+
---------	------	-------------------------------------	---------------------------------------