

**CONFIDENTIAL**

This document is the property of Evapco, Inc. It should not be copied or disclosed without prior written authorization.

|          |                                |              |                        |        |                |
|----------|--------------------------------|--------------|------------------------|--------|----------------|
| CUSTOMER | MODEL # U-SSTME2-2164H0075F1LA | SCALE N.T.S. | DWG. # USSTM2-SE-16,18 | REV. 0 | DATE 4/26/2026 |
|----------|--------------------------------|--------------|------------------------|--------|----------------|



**NOTES:**

- 1) \* = HANGER HOLE LOCATION.
- 2) RIGHT HAND MODEL SHOWN.
- 3) HANGER HOLES ARE FOR 3/4 INCH THREADED ROD.
- 4) ALL DIMENSIONS ARE FOR REFERENCE AND SHOULD NOT BE USED FOR PREFABRICATION OF PIPING OR SUPPORTS.

NEMA 4X  
JUNCTION BOX

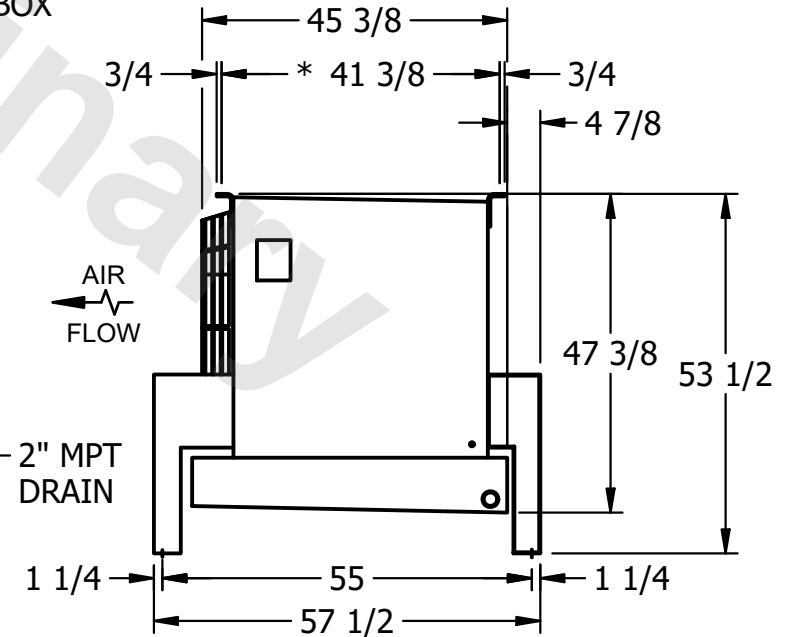

|         |      |                                     |                                      |
|---------|------|-------------------------------------|--------------------------------------|
| PROJECT | ROOM | SHIPPING WEIGHT 1140 lbs+ [520] kg+ | OPERATING WEIGHT 1290 lbs+ [590] kg+ |
|---------|------|-------------------------------------|--------------------------------------|