

UNIT	CONDENSER	
MODEL #	PMRC-678	SCALE NTS

# EVAPCO, INC.



DWG. #	CEWR121214-DRA-ST	REV	-
SERIAL #		DATE:	6/18/2026

**NOTES:**

- (M)- FAN MOTOR LOCATION.
- MPT DENOTES MALE PIPE THREAD  
FPT DENOTES FEMALE PIPE THREAD  
BFW DENOTES BEVELED FOR WELDING  
GVD DENOTES GROOVED  
FLG DENOTES FLANGE  
PE DENOTES PLAIN END
- +UNIT WEIGHT DOES NOT INCLUDE ACCESSORIES (SEE ACCESSORY DRAWINGS).
- 3/4" [19mm] DIA. MOUNTING HOLES. REFER TO RECOMMENDED STEEL SUPPORT DRAWING.
- MAKE-UP WATER PRESSURE 20 psi [137 kPa] MIN, 50 psi [344 kPa] MAX.
- DIMENSIONS LISTED AS FOLLOWS:  
ENGLISH FT-IN  
[METRIC] [mm]
- \* - APPROXIMATE DIMENSIONS DO NOT USE FOR PRE-FABRICATION OF CONNECTING PIPING.

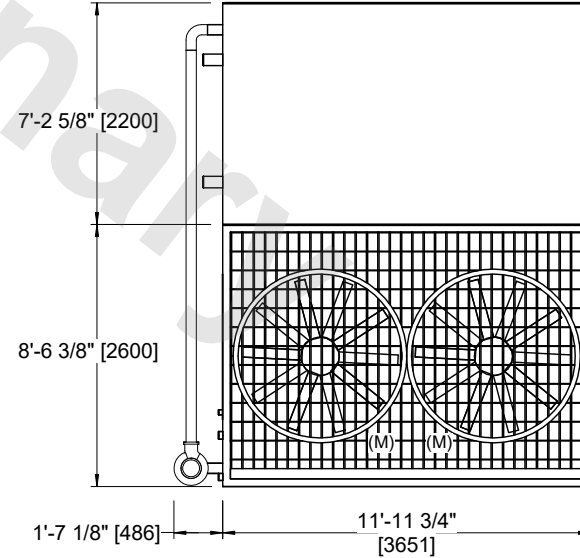
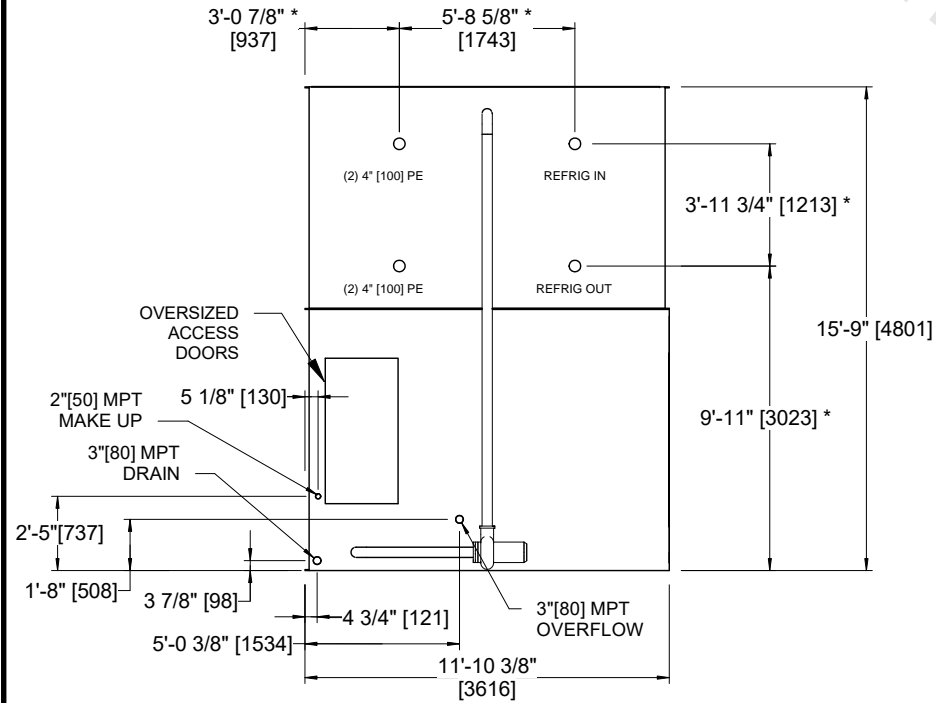

**FACE B**

**FACE A**

SHIPPING WEIGHT	25880 lbs+ [11740] kg+	OPERATING WEIGHT	30960 lbs+ [14045] kg+	HEAVIEST SECTION WEIGHT	19620 lbs+ [8900] kg+	NO. OF SHIPPING SECTIONS	2	DRAWN BY:	JLG
-----------------	------------------------	------------------	------------------------	-------------------------	-----------------------	--------------------------	---	-----------	-----