

UNIT	CONDENSER	
MODEL #	eco-PMRC-1111	SCALE NTS

# EVAPCO, INC.



DWG. #	CEWR122406-DRA-ST	REV	-
SERIAL #		DATE:	6/9/2026

- NOTES:**
- (M)- FAN MOTOR LOCATION.
  - MPT DENOTES MALE PIPE THREAD  
FPT DENOTES FEMALE PIPE THREAD  
BFW DENOTES BEVELED FOR WELDING  
GVD DENOTES GROOVED  
FLG DENOTES FLANGE  
PE DENOTES PLAIN END
  - +UNIT WEIGHT DOES NOT INCLUDE ACCESSORIES (SEE ACCESSORY DRAWINGS).
  - 3/4" [19mm] DIA. MOUNTING HOLES. REFER TO RECOMMENDED STEEL SUPPORT DRAWING.
  - MAKE-UP WATER PRESSURE 20 psi [137 kPa] MIN, 50 psi [344 kPa] MAX.
  - DIMENSIONS LISTED AS FOLLOWS:  
ENGLISH FT-IN  
[METRIC] [mm]
  - \* - APPROXIMATE DIMENSIONS DO NOT USE FOR PRE-FABRICATION OF CONNECTING PIPING.

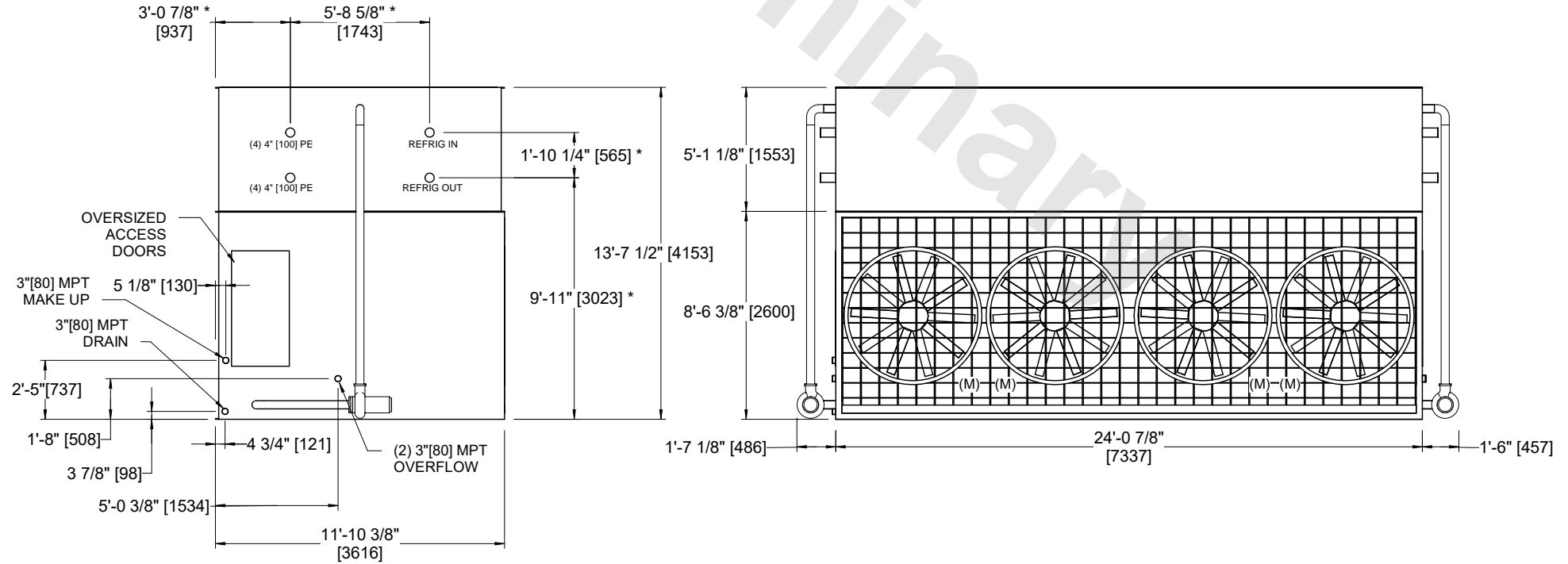

**FACE B**

**FACE A**

SHIPPING WEIGHT	36240 lbs+ [16440] kg+	OPERATING WEIGHT	45890 lbs+ [20820] kg+	HEAVIEST SECTION WEIGHT	12470 lbs+ [5660] kg+	NO. OF SHIPPING SECTIONS	3	DRAWN BY:	JLG
-----------------	------------------------	------------------	------------------------	-------------------------	-----------------------	--------------------------	---	-----------	-----