

| | | |
|---------|--------------|-----------|
| UNIT | CONDENSER | |
| MODEL # | eco-PMRC-632 | SCALE NTS |

EVAPCO, INC.

| | | | |
|----------|-------------------|-------|-----------|
| DWG. # | CEWR121810-DRA-ST | REV | - |
| SERIAL # | | DATE: | 6/18/2026 |

- NOTES:**
- (M)- FAN MOTOR LOCATION.
 - MPT DENOTES MALE PIPE THREAD
FPT DENOTES FEMALE PIPE THREAD
BFW DENOTES BEVELED FOR WELDING
GVD DENOTES GROOVED
FLG DENOTES FLANGE
PE DENOTES PLAIN END
 - +UNIT WEIGHT DOES NOT INCLUDE ACCESSORIES (SEE ACCESSORY DRAWINGS).
 - 3/4" [19mm] DIA. MOUNTING HOLES. REFER TO RECOMMENDED STEEL SUPPORT DRAWING.
 - MAKE-UP WATER PRESSURE 20 psi [137 kPa] MIN, 50 psi [344 kPa] MAX.
 - DIMENSIONS LISTED AS FOLLOWS:
ENGLISH FT-IN
[METRIC] [mm]
 - * - APPROXIMATE DIMENSIONS DO NOT USE FOR PRE-FABRICATION OF CONNECTING PIPING.

**FACE B
PLAN VIEW**

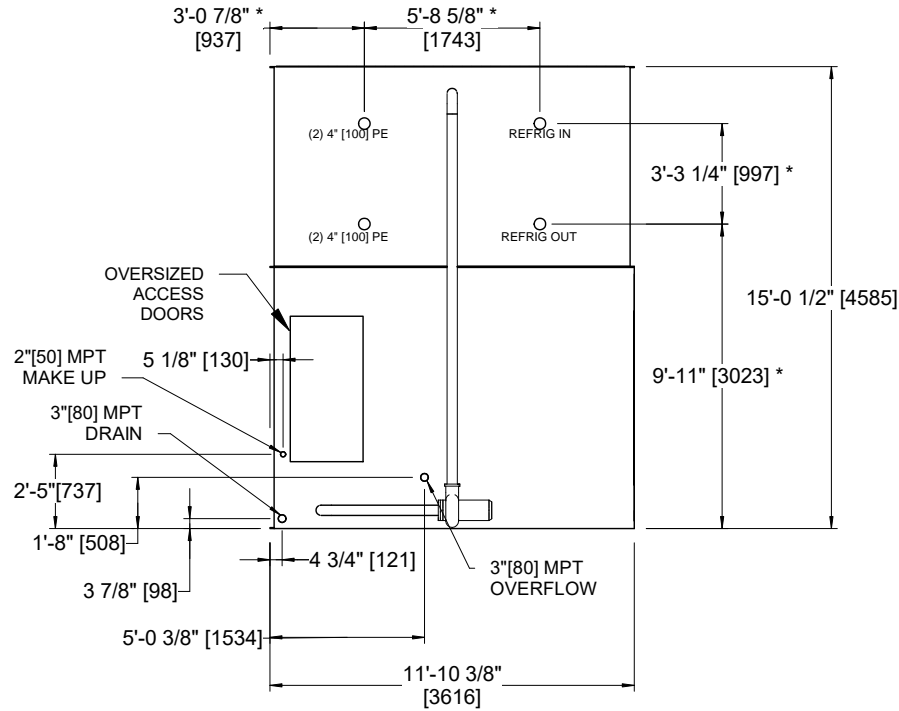

FACE B

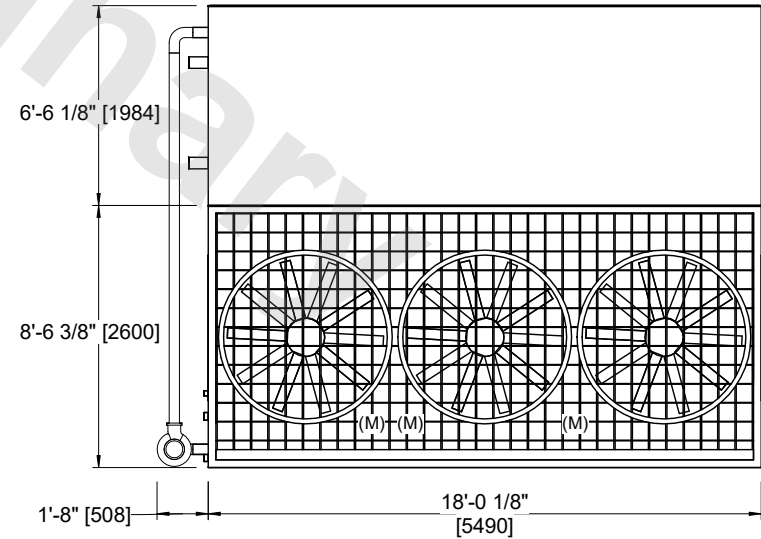

FACE A

| | | | | | | | | | |
|-----------------|------------------------|------------------|------------------------|-------------------------|------------------------|--------------------------|---|-----------|-----|
| SHIPPING WEIGHT | 37060 lbs+ [16815] kg+ | OPERATING WEIGHT | 44150 lbs+ [20030] kg+ | HEAVIEST SECTION WEIGHT | 28930 lbs+ [13125] kg+ | NO. OF SHIPPING SECTIONS | 2 | DRAWN BY: | JLG |
|-----------------|------------------------|------------------|------------------------|-------------------------|------------------------|--------------------------|---|-----------|-----|