

CONFIDENTIAL

This document is the property of Evapco, Inc. It should not be copied or disclosed without prior written authorization.

| | | | | | |
|----------|---------------------------------|--------------|----------------------|--------|---------------|
| CUSTOMER | MODEL # U-EJETME3-4286F0100F1KA | SCALE N.T.S. | DWG. # UEJETM3-SE-24 | REV. 0 | DATE 5/4/2026 |
|----------|---------------------------------|--------------|----------------------|--------|---------------|



NOTES:

- 1) * = HANGER HOLE LOCATION.
- 2) RIGHT HAND MODEL SHOWN.
- 3) HANGER HOLES ARE FOR 3/4 INCH THREADED ROD.
- 4) WATER DEFROST ADDS 1 3/4" INCHES TO HEIGHT OF STANDARD UNIT AND CHANGES DRAIN SIZE.
- 5) ALL DIMENSIONS ARE FOR REFERENCE AND SHOULD NOT BE USED FOR PREFABRICATION OF PIPING OR SUPPORTS.
- 6) **= HEIGHT OF SUCTION HEADER AND INSTALLED THERMOWELL FITTING ABOVE CABINET. CUSTOMER IS RESPONSIBLE TO ACCOUNT FOR ADDITIONAL HEIGHT NECESSARY FOR RTD AND ACCESS.

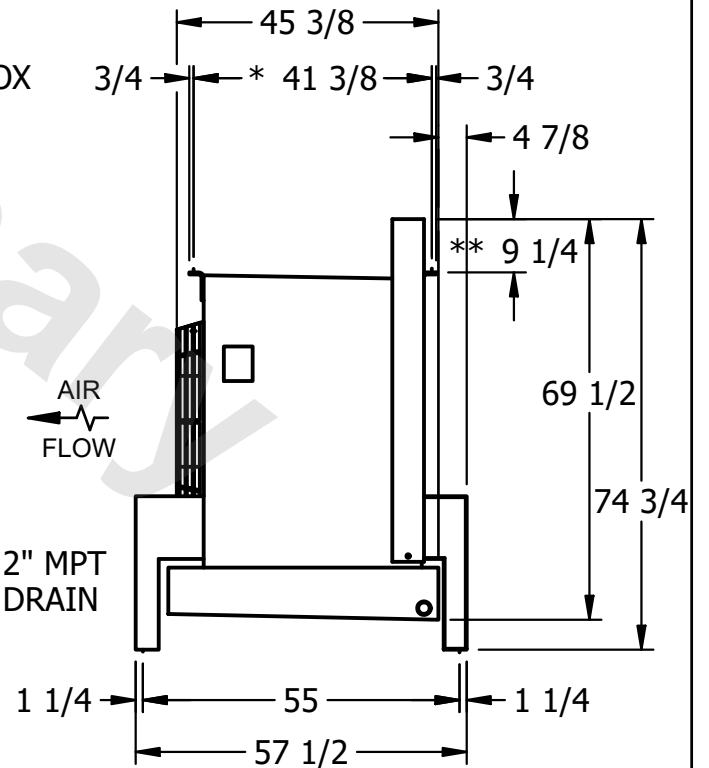

| | | | |
|---------|------|-------------------------------------|---------------------------------------|
| PROJECT | ROOM | SHIPPING WEIGHT 2030 lbs+ [925] kg+ | OPERATING WEIGHT 2550 lbs+ [1160] kg+ |
|---------|------|-------------------------------------|---------------------------------------|