

**CONFIDENTIAL**

This document is the property of Evapco, Inc. It should not be copied or disclosed without prior written authorization.

CUSTOMER	MODEL # U-EJETME1-963F0075F1JA	SCALE N.T.S.	DWG. # UEJETM1-SE-16,18	REV. 0	DATE 6/24/2026
----------	--------------------------------	--------------	-------------------------	--------	----------------



NEMA 4X JUNCTION BOX

**NOTES:**

- 1) \* = HANGER HOLE LOCATION.
- 2) RIGHT HAND MODEL SHOWN.
- 3) HANGER HOLES ARE FOR 3/4 INCH THREADED ROD.
- 4) WATER DEFROST ADDS 1 3/4" INCHES TO HEIGHT OF STANDARD UNIT AND CHANGES DRAIN SIZE.
- 5) ALL DIMENSIONS ARE FOR REFERENCE AND SHOULD NOT BE USED FOR PREFABRICATION OF PIPING OR SUPPORTS.
- 6) \*\*= HEIGHT OF SUCTION HEADER AND INSTALLED THERMOWELL FITTING ABOVE CABINET. CUSTOMER IS RESPONSIBLE TO ACCOUNT FOR ADDITIONAL HEIGHT NECESSARY FOR RTD AND ACCESS.

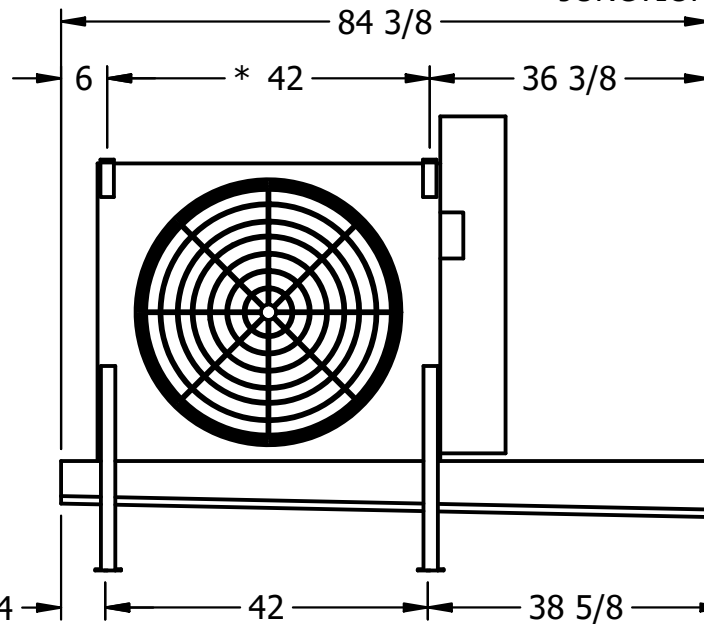

2" MPT DRAIN



PROJECT	ROOM	SHIPPING WEIGHT 560 lbs+ [255] kg+	OPERATING WEIGHT 620 lbs+ [285] kg+
---------	------	------------------------------------	-------------------------------------