

**CONFIDENTIAL**

This document is the property of Evapco, Inc. It should not be copied or disclosed without prior written authorization.

CUSTOMER	MODEL # U-EJETME5-5383H0100F1JA	SCALE N.T.S.	DWG. # UEJETM5-SE-16,18	REV. 0	DATE 6/14/2026
----------	---------------------------------	--------------	-------------------------	--------	----------------



**NOTES:**

- 1) \* = HANGER HOLE LOCATION.
- 2) RIGHT HAND MODEL SHOWN.
- 3) HANGER HOLES ARE FOR 3/4 INCH THREADED ROD.
- 4) WATER DEFROST ADDS 1 3/4" INCHES TO HEIGHT OF STANDARD UNIT AND CHANGES DRAIN SIZE.
- 5) ALL DIMENSIONS ARE FOR REFERENCE AND SHOULD NOT BE USED FOR PREFABRICATION OF PIPING OR SUPPORTS.
- 6) \*\*= HEIGHT OF SUCTION HEADER AND INSTALLED THERMOWELL FITTING ABOVE CABINET. CUSTOMER IS RESPONSIBLE TO ACCOUNT FOR ADDITIONAL HEIGHT NECESSARY FOR RTD AND ACCESS.

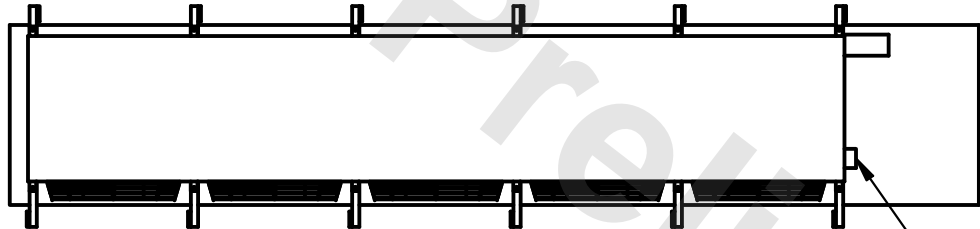

NEMA 4X  
JUNCTION BOX



2" MPT  
DRAIN

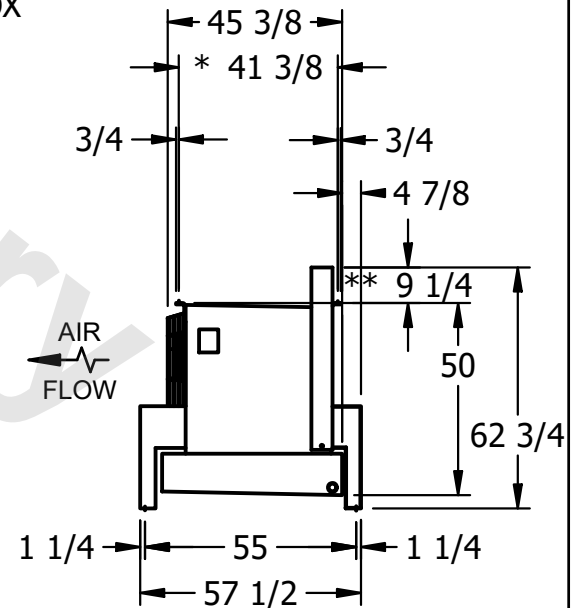

AIR  
FLOW

PROJECT	ROOM	SHIPPING WEIGHT 2900 lbs+ [1320] kg+	OPERATING WEIGHT 3310 lbs+ [1505] kg+
---------	------	--------------------------------------	---------------------------------------