

**CONFIDENTIAL**

This document is the property of Evapco, Inc. It should not be copied or disclosed without prior written authorization.

CUSTOMER	MODEL # U-EJETME3-4243F0150H1JA	SCALE N.T.S.	DWG. # UEJETM3-SE-24	REV. 0	DATE 9/28/2025
----------	---------------------------------	--------------	----------------------	--------	----------------

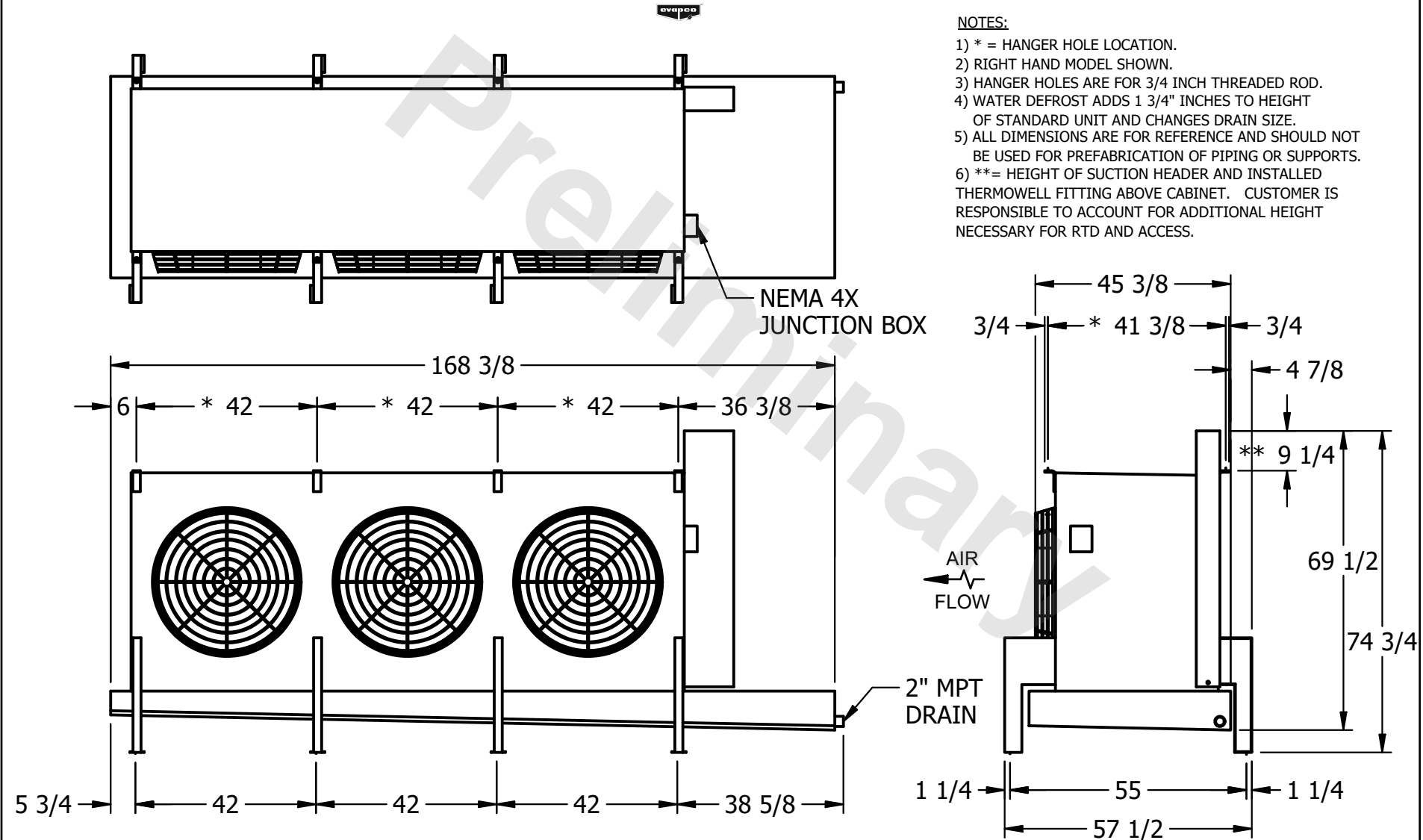

PROJECT	ROOM	SHIPPING WEIGHT 1360 lbs+ [620] kg+	OPERATING WEIGHT 1530 lbs+ [695] kg+
---------	------	-------------------------------------	--------------------------------------