

EVAPCO, INC.



UNIT EVAPORATIVE CONDENSER	MODEL # ATC-DC-1240M-25-1EF	SCALE N.T.S.	DWG. # EGCH124002-DRB-ST	REV. -	DATE 6/21/2026	SERIAL #
-------------------------------	--------------------------------	-----------------	-----------------------------	-----------	-------------------	----------

- NOTES:
- (M)- FAN MOTOR LOCATION
 - HEAVIEST SECTION IS COIL SECTION
 - MPT DENOTES MALE PIPE THREAD
FPT DENOTES FEMALE PIPE THREAD
BFW DENOTES BEVELED FOR WELDING
 - +UNIT WEIGHT DOES NOT INCLUDE ACCESSORIES (SEE ACCESSORY DRAWINGS)
 - MAKE-UP WATER PRESSURE
20 psi MIN [137 kPa], 50 psi MAX [344 kPa]

- DIMENSIONS LISTED AS FOLLOWS:
ENGLISH IN
[METRIC] [mm]
- * - APPROXIMATE DIMENSIONS DO NOT USE FOR PRE-FABRICATION OF CONNECTING PIPING.

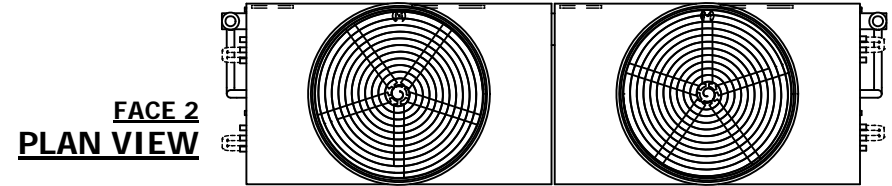

FACE 1

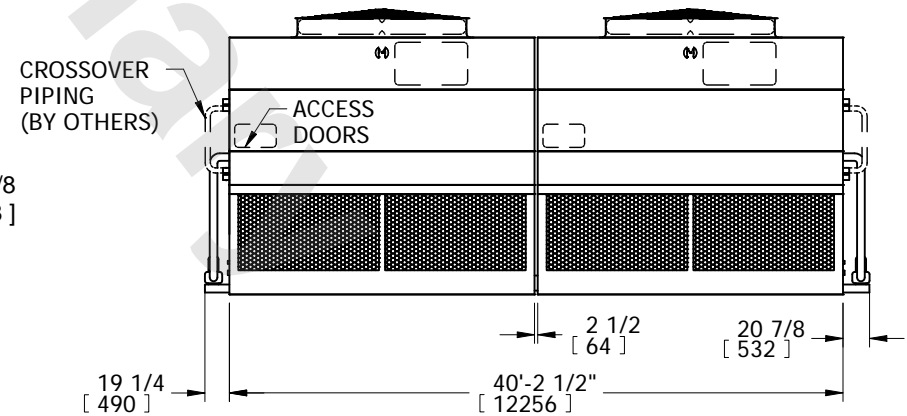
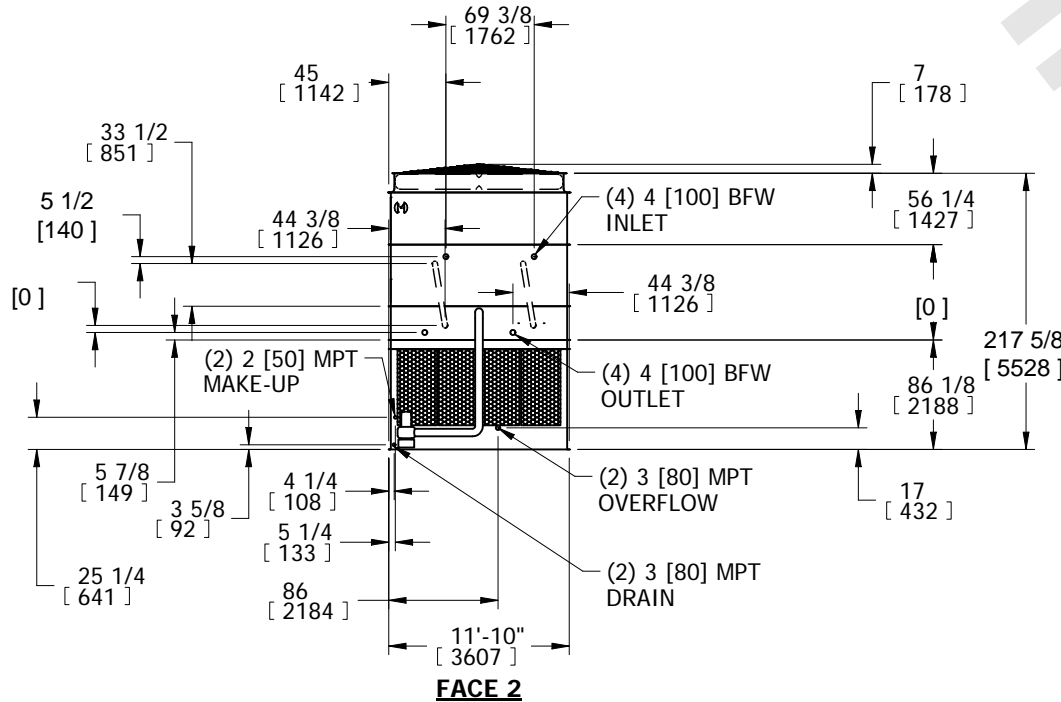

SHIPPING WEIGHT 51320 lbs+ [23280] kg+	OPERATING WEIGHT 74500 lbs+ [33795] kg+	HEAVIEST SECTION WEIGHT 20580 lbs+ [9335] kg+	NO. OF SHIPPING SECTIONS 6	DRAWN BY: SFR
---	--	--	-------------------------------	------------------