

# EVAPCO, INC.



UNIT EVAPORATIVE CONDENSER	MODEL # ATC-DC-1212L-25-1EF	SCALE N.T.S.	DWG. # EGCH121202-DRB-ST	REV. -	DATE 4/29/2026	SERIAL #
-------------------------------	--------------------------------	-----------------	-----------------------------	-----------	-------------------	----------

- NOTES:
- (M)- FAN MOTOR LOCATION
  - HEAVIEST SECTION IS COIL SECTION
  - MPT DENOTES MALE PIPE THREAD  
FPT DENOTES FEMALE PIPE THREAD  
BFW DENOTES BEVELED FOR WELDING
  - +UNIT WEIGHT DOES NOT INCLUDE ACCESSORIES (SEE ACCESSORY DRAWINGS)
  - MAKE-UP WATER PRESSURE  
20 psi MIN [137 kPa], 50 psi MAX [344 kPa]

- DIMENSIONS LISTED AS FOLLOWS:  
ENGLISH IN  
[METRIC] [mm]
- \* - APPROXIMATE DIMENSIONS DO NOT USE FOR PRE-FABRICATION OF CONNECTING PIPING.

**FACE 2  
PLAN VIEW**

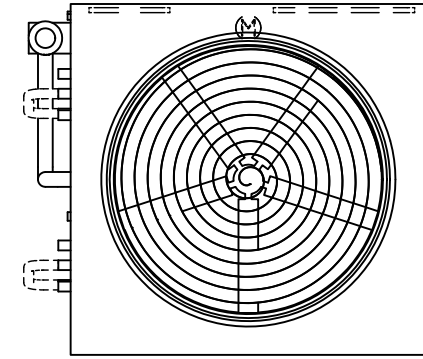

**FACE 1**

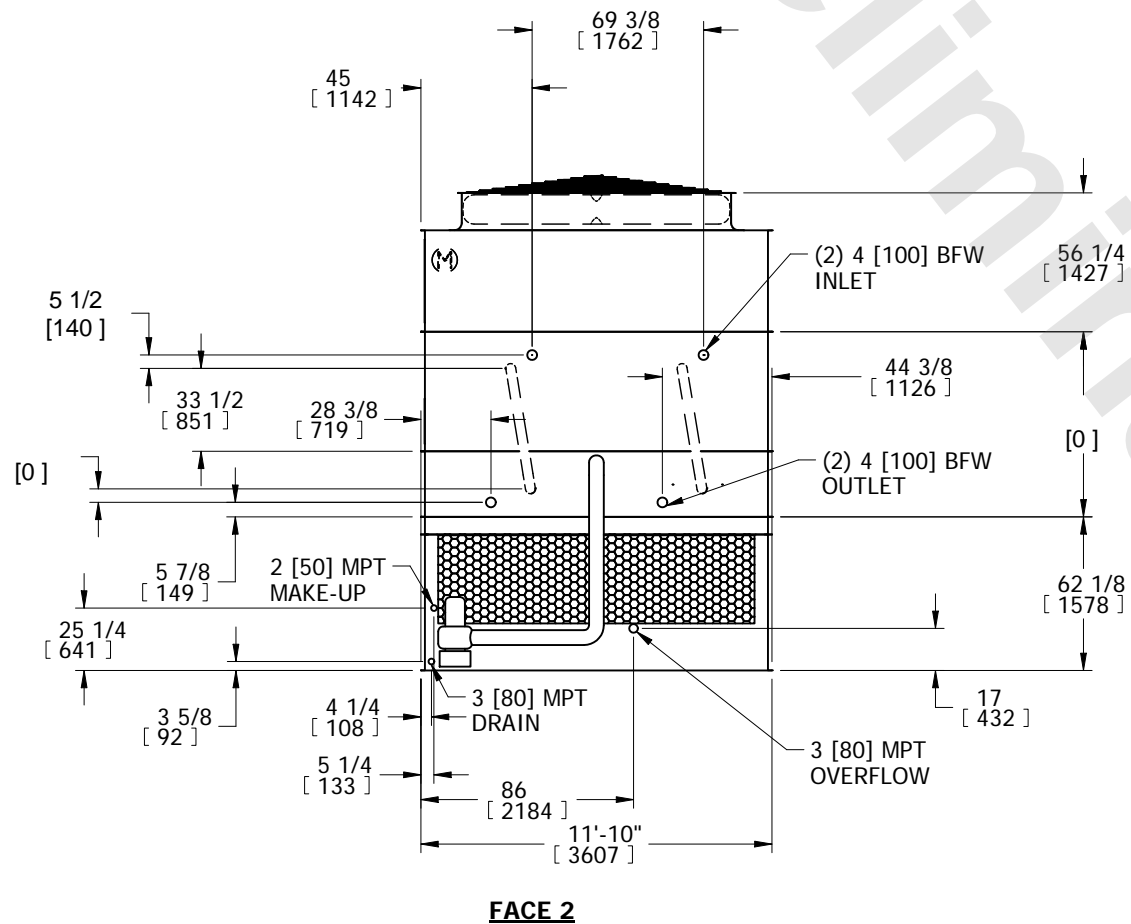

**FACE 2**

CROSSOVER PIPING (BY OTHERS)

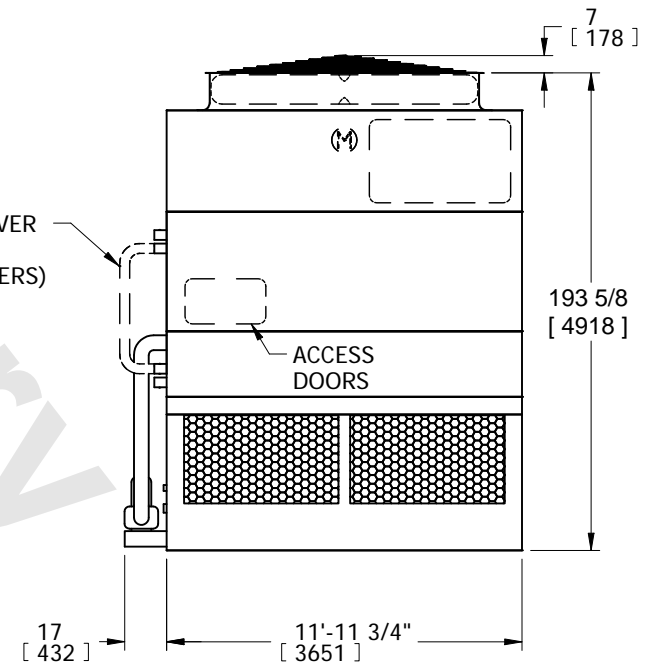

**FACE 1**

SHIPPING WEIGHT 16770 lbs+ [7610] kg+	OPERATING WEIGHT 22880 lbs+ [10380] kg+	HEAVIEST SECTION WEIGHT 11140 lbs+ [5055] kg+	NO. OF SHIPPING SECTIONS 3	DRAWN BY: SFR
--	--	--	-------------------------------	------------------