

UNIT	COOLING TOWER	
MODEL #	AT 210-4L24	SCALE NTS

EVAPCO, INC.

DWG. #	T3TM2448-DRD-ST	REV.	-
SERIAL #		DATE	4/3/2026

- NOTES:
1. (M)- FAN MOTOR LOCATION
 2. HEAVIEST SECTION IS UPPER SECTION
 3. MPT DENOTES MALE PIPE THREAD
FPT DENOTES FEMALE PIPE THREAD
BFW DENOTES BEVELED FOR WELDING
GVD DENOTES GROOVED
FLG DENOTES FLANGE
 4. +UNIT WEIGHT DOES NOT INCLUDE ACCESSORIES (SEE ACCESSORY DRAWINGS)
 5. MAKE-UP WATER PRESSURE
20 psi MIN [137 kPa], 50 psi MAX [344 kPa]
 6. 3/4" [19MM] DIA. MOUNTING HOLES. REFER TO RECOMENDED STEEL SUPPORT DRAWING.
 7. DIMENSIONS LISTED AS FOLLOWS:
ENGLISH FT-IN
[METRIC] [mm]

FACE B
PLAN VIEW



FACE A

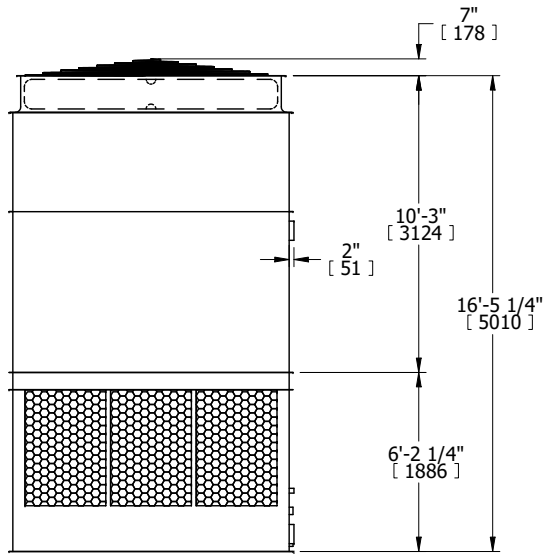

FACE B

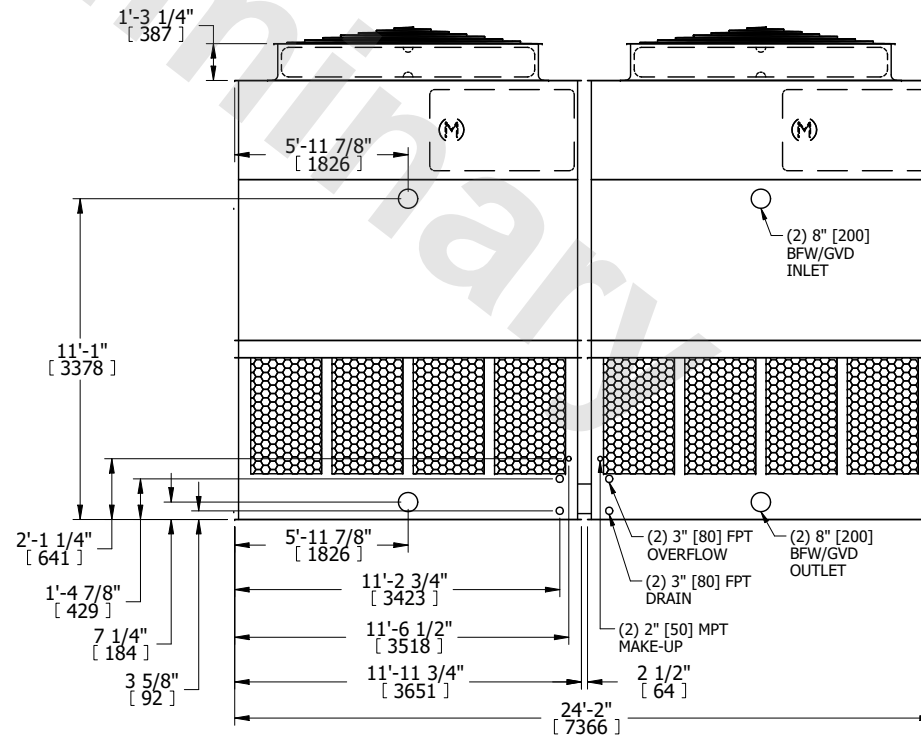

FACE A

SHIPPING WEIGHT	15420 lbs+ [6995] kg+	OPERATING WEIGHT	25340 lbs+ [11495] kg+	HEAVIEST SECTION WEIGHT	5270 lbs+ [2395] kg+	NO. OF SHIPPING SECTIONS	4	DRAWN BY:	JLG
-----------------	-----------------------	------------------	------------------------	-------------------------	----------------------	--------------------------	---	-----------	-----