

UNIT	COOLING TOWER	
MODEL #	AT 14-2E4	SCALE NTS



DWG. #	T3040424-DRJ-ST	REV.	-
SERIAL #		DATE	4/25/2026

- NOTES:
- (M)- FAN MOTOR LOCATION
 - HEAVIEST SECTION IS UPPER SECTION
 - MPT DENOTES MALE PIPE THREAD
FPT DENOTES FEMALE PIPE THREAD
BFW DENOTES BEVELED FOR WELDING
GVD DENOTES GROOVED
FLG DENOTES FLANGE
 - +UNIT WEIGHT DOES NOT INCLUDE ACCESSORIES (SEE ACCESSORY DRAWINGS)
 - MAKE-UP WATER PRESSURE
20 psi MIN [137 kPa], 50 psi MAX [344 kPa]
 - 3/4" [19MM] DIA. MOUNTING HOLES. REFER TO RECOMMENDED STEEL SUPPORT DRAWING.
 - DIMENSIONS LISTED AS FOLLOWS:
ENGLISH FT-IN
[METRIC] [mm]

FACE B
PLAN VIEW

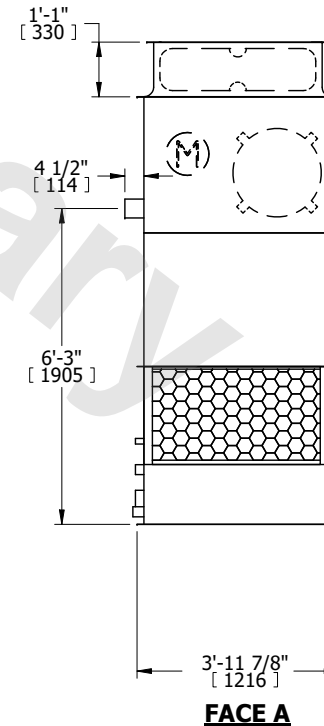
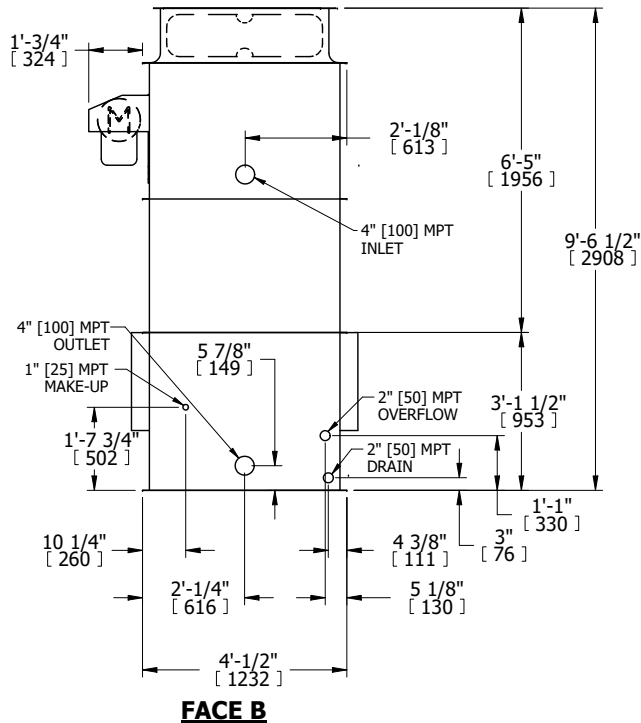
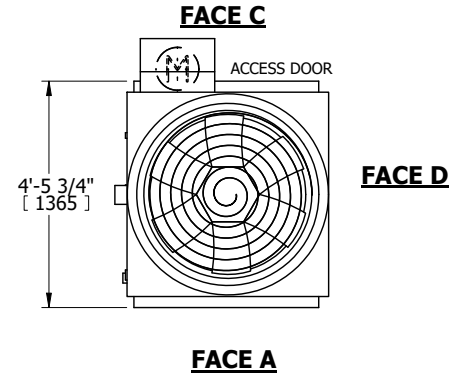

SHIPPING WEIGHT	1080 lbs+ [490] kg+	OPERATING WEIGHT	1710 lbs+ [780] kg+	HEAVIEST SECTION WEIGHT	730 lbs+ [335] kg+	NO. OF SHIPPING SECTIONS	2	DRAWN BY:	KWC
-----------------	---------------------	------------------	---------------------	-------------------------	--------------------	--------------------------	---	-----------	-----