

UNIT	COOLING TOWER	
MODEL #	AT 14-3E9	SCALE NTS

EVAPCO, INC.

DWG. #	T3040936-DRJ-ST	REV.	-
SERIAL #		DATE	6/28/2026

- NOTES:
- (M)- FAN MOTOR LOCATION
 - HEAVIEST SECTION IS UPPER SECTION
 - MPT DENOTES MALE PIPE THREAD
FPT DENOTES FEMALE PIPE THREAD
BFW DENOTES BEVELED FOR WELDING
GVD DENOTES GROOVED
FLG DENOTES FLANGE
 - +UNIT WEIGHT DOES NOT INCLUDE ACCESSORIES (SEE ACCESSORY DRAWINGS)
 - MAKE-UP WATER PRESSURE
20 psi MIN [137 kPa], 50 psi MAX [344 kPa]
 - 3/4" [19MM] DIA. MOUNTING HOLES. REFER TO RECOMMENDED STEEL SUPPORT DRAWING.
 - DIMENSIONS LISTED AS FOLLOWS:
ENGLISH FT-IN
[METRIC] [mm]

**FACE B
PLAN VIEW**

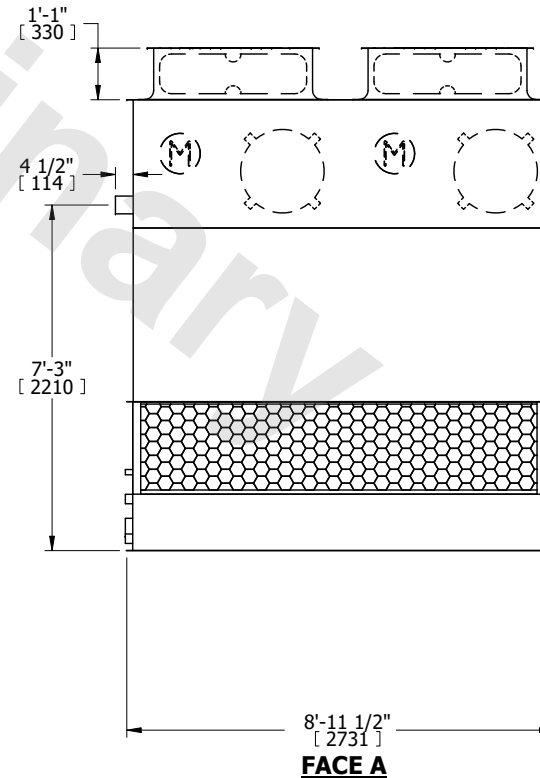
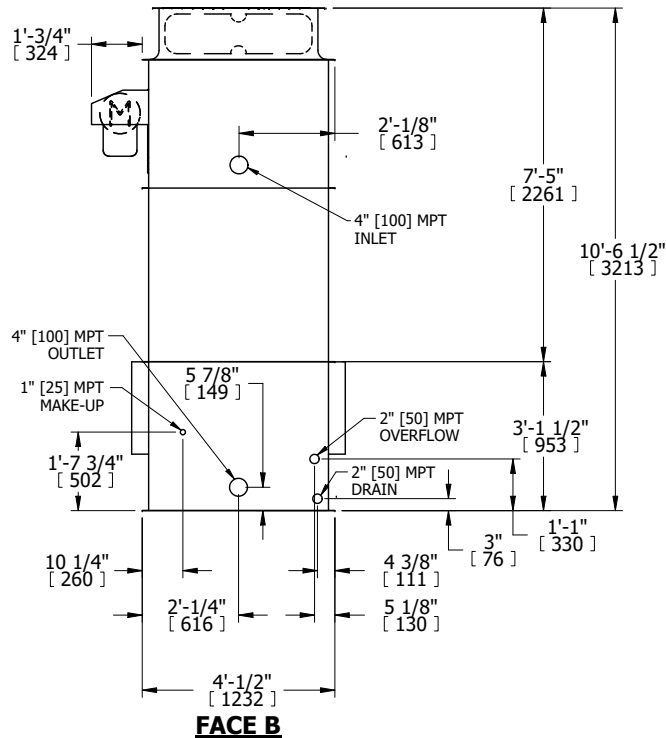
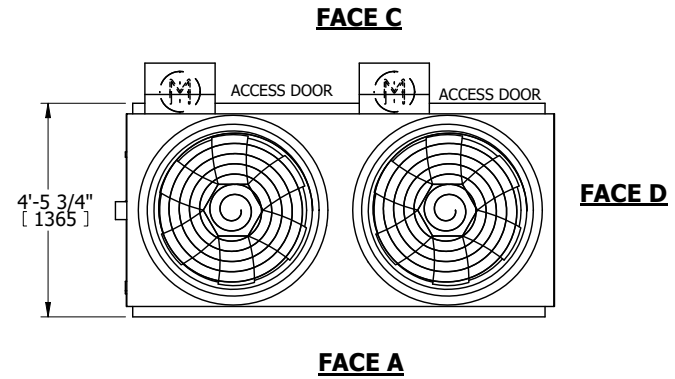

SHIPPING WEIGHT	2160 lbs+ [980] kg+	OPERATING WEIGHT	3710 lbs+ [1685] kg+	HEAVIEST SECTION WEIGHT	1540 lbs+ [700] kg+	NO. OF SHIPPING SECTIONS	2	DRAWN BY:	KWC
-----------------	---------------------	------------------	----------------------	-------------------------	---------------------	--------------------------	---	-----------	-----