

UNIT	COOLING TOWER	
MODEL #	AT 217-3112	SCALE NTS

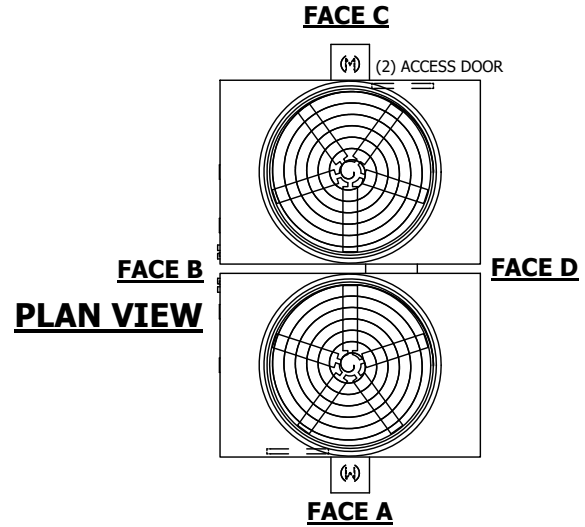

DWG. #	T3171236-DRG-ST	REV.	-
SERIAL #		DATE	7/10/2026

- NOTES:
- (M)- FAN MOTOR LOCATION
 - HEAVIEST SECTION IS UPPER SECTION
 - MPT DENOTES MALE PIPE THREAD
FPT DENOTES FEMALE PIPE THREAD
BFW DENOTES BEVELED FOR WELDING
GVD DENOTES GROOVED
FLG DENOTES FLANGE
 - +UNIT WEIGHT DOES NOT INCLUDE ACCESSORIES (SEE ACCESSORY DRAWINGS)
 - MAKE-UP WATER PRESSURE
20 psi MIN [137 kPa], 50 psi MAX [344 kPa]
 - 3/4" [19MM] DIA. MOUNTING HOLES.
REFER TO RECOMMENDED STEEL SUPPORT DRAWING
 - DIMENSIONS LISTED AS FOLLOWS:
ENGLISH FT-IN
[METRIC] [mm]



SHIPPING WEIGHT	11340 lbs+ [5145] kg+	OPERATING WEIGHT	19060 lbs+ [8650] kg+	HEAVIEST SECTION WEIGHT	3820 lbs+ [1735] kg+	NO. OF SHIPPING SECTIONS	4	DRAWN BY:	KDS
-----------------	-----------------------	------------------	-----------------------	-------------------------	----------------------	--------------------------	---	-----------	-----