

EVAPCO, INC.



UNIT COOLING TOWER	MODEL # AT 420-3J36	SCALE N.T.S.	DWG. # T36M3636-DRE-ST	REV. -	DATE 3/26/2026	SERIAL #
------------------------------	------------------------	-----------------	---------------------------	-----------	-------------------	----------

- NOTES:
- (M)- FAN MOTOR LOCATION
 - HEAVIEST SECTION IS UPPER SECTION
 - MPT DENOTES MALE PIPE THREAD
FPT DENOTES FEMALE PIPE THREAD
BFW DENOTES BEVELED FOR WELDING
 - +UNIT WEIGHT DOES NOT INCLUDE ACCESSORIES (SEE ACCESSORY DRAWINGS)
 - MAKE-UP WATER PRESSURE
20 psi MIN [137 kPa], 50 psi MAX [344 kPa]

**FACE 2
PLAN VIEW**



FACE 1

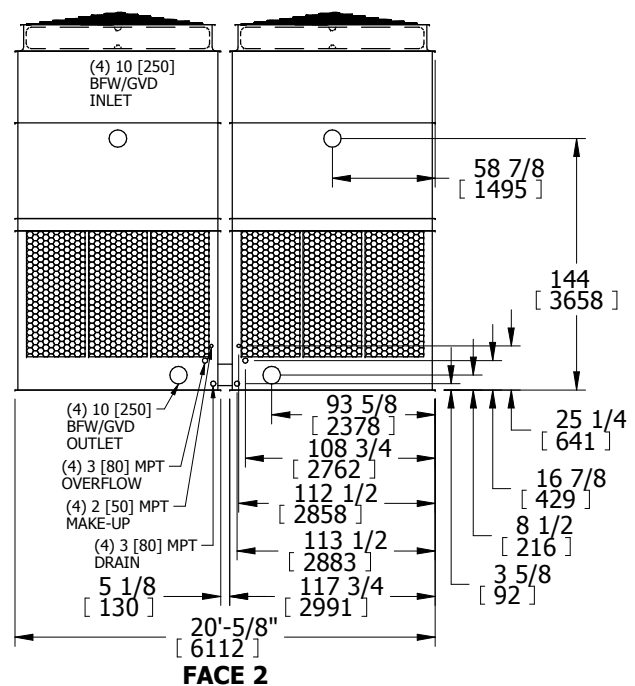

FACE 2

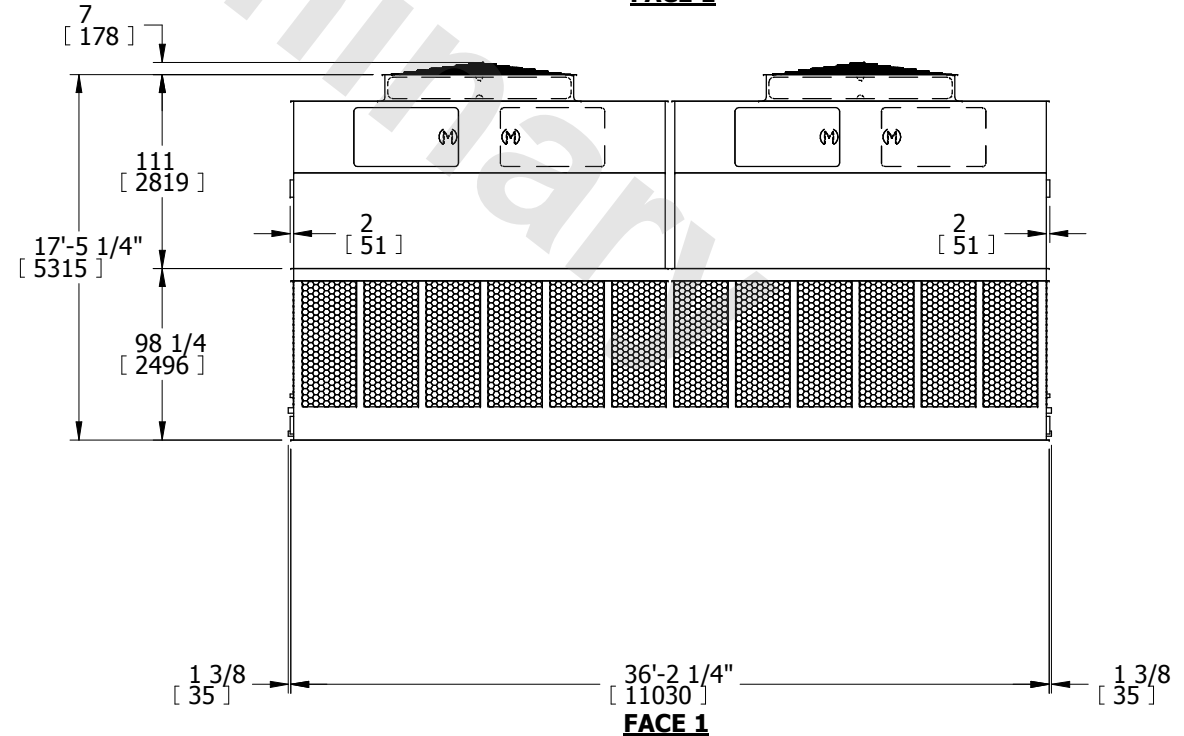

FACE 1

SHIPPING WEIGHT 40140 lbs+ [18207] kg+	OPERATING WEIGHT 74100 lbs+ [33611] kg+	HEAVIEST SECTION WEIGHT 6850 lbs+ [3107] kg+	NO. OF SHIPPING SECTIONS 6
---	--	---	-------------------------------