

UNIT	COOLING TOWER	
MODEL #	AT 112-3114	SCALE NTS

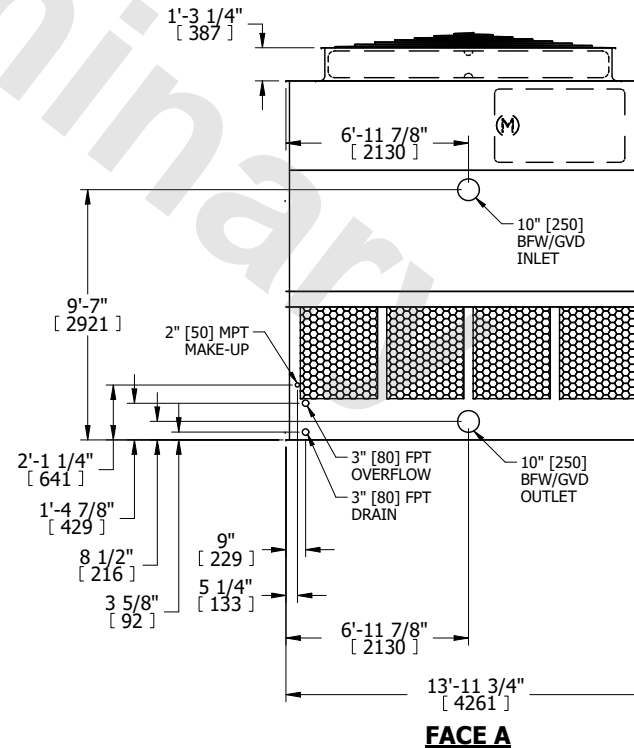

DWG. #	T3121436-DRE-ST	REV.	-
SERIAL #		DATE	4/21/2026

- NOTES:
- (M)- FAN MOTOR LOCATION
 - HEAVIEST SECTION IS UPPER SECTION
 - MPT DENOTES MALE PIPE THREAD
FPT DENOTES FEMALE PIPE THREAD
BFW DENOTES BEVELED FOR WELDING
GVD DENOTES GROOVED
FLG DENOTES FLANGE
 - +UNIT WEIGHT DOES NOT INCLUDE ACCESSORIES (SEE ACCESSORY DRAWINGS)
 - MAKE-UP WATER PRESSURE
20 psi MIN [137 kPa], 50 psi MAX [344 kPa]
 - 3/4" [19MM] DIA. MOUNTING HOLES.
REFER TO RECOMMENDED STEEL SUPPORT DRAWING
 - DIMENSIONS LISTED AS FOLLOWS:
ENGLISH FT-IN
[METRIC] [mm]

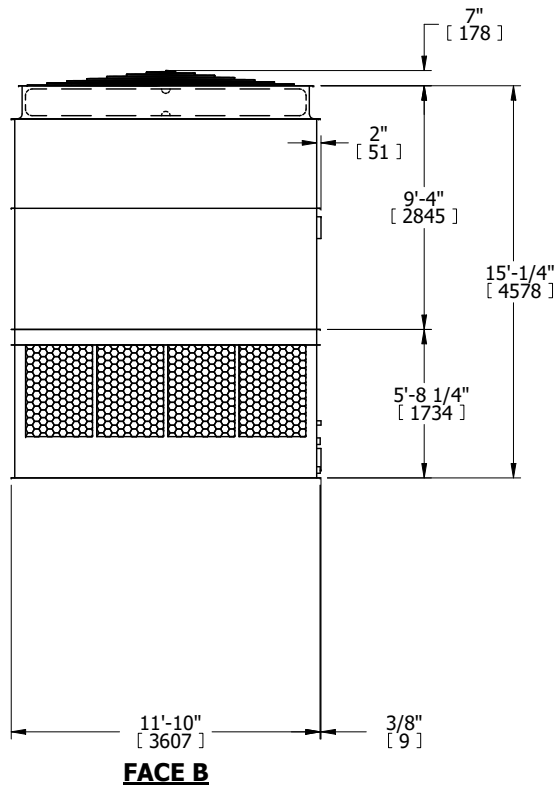
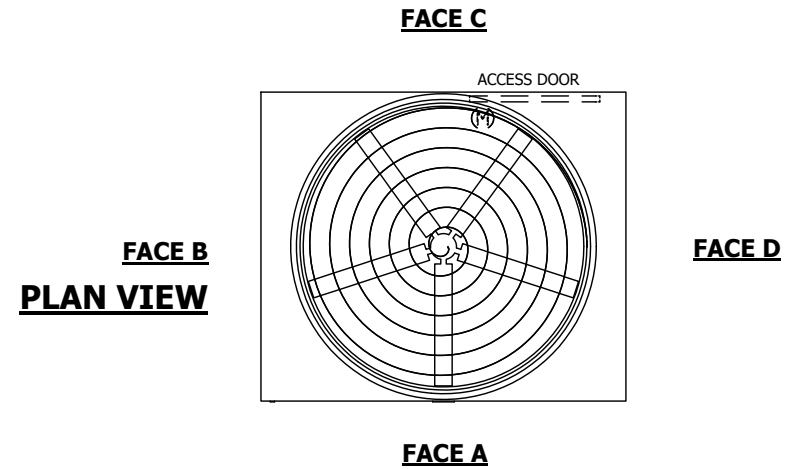

SHIPPING WEIGHT	8890 lbs+ [4035] kg+	OPERATING WEIGHT	16220 lbs+ [7360] kg+	HEAVIEST SECTION WEIGHT	6020 lbs+ [2735] kg+	NO. OF SHIPPING SECTIONS	2	DRAWN BY:	KDS
-----------------	----------------------	------------------	-----------------------	-------------------------	----------------------	--------------------------	---	-----------	-----