

UNIT	COOLING TOWER	
MODEL #	AT 212-3040	SCALE NTS

# EVAPCO, INC.



DWG. #	T3124036-DRB-ST	REV.	-
SERIAL #		DATE	5/4/2026

- NOTES:**
- (M)- FAN MOTOR LOCATION
  - HEAVIEST SECTION IS UPPER SECTION
  - MPT DENOTES MALE PIPE THREAD  
FPT DENOTES FEMALE PIPE THREAD  
BFW DENOTES BEVELED FOR WELDING  
GVD DENOTES GROOVED  
FLG DENOTES FLANGE
  - +UNIT WEIGHT DOES NOT INCLUDE ACCESSORIES (SEE ACCESSORY DRAWINGS)
  - MAKE-UP WATER PRESSURE  
20 psi MIN [137 kPa], 50 psi MAX [344 kPa]
  - 3/4" [19MM] DIA. MOUNTING HOLES. REFER TO RECOMENDED STEEL SUPPORT DRAWING.
  - DIMENSIONS LISTED AS FOLLOWS:  
ENGLISH FT-IN  
[METRIC] [mm]

**FACE B  
PLAN VIEW**

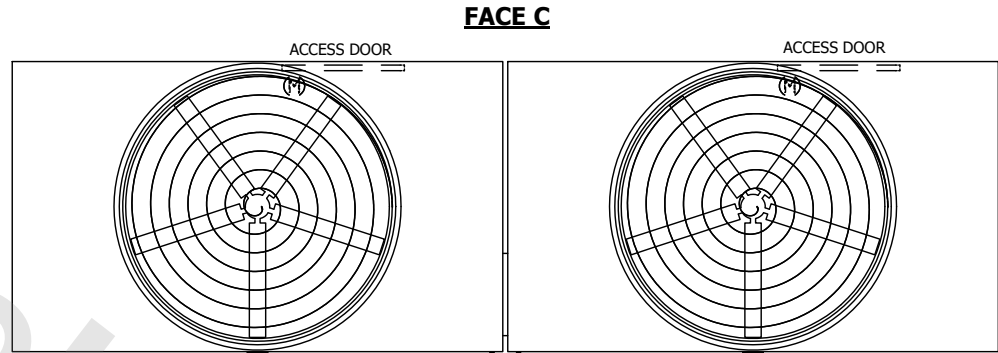

**FACE D**

**FACE A**



**FACE B**

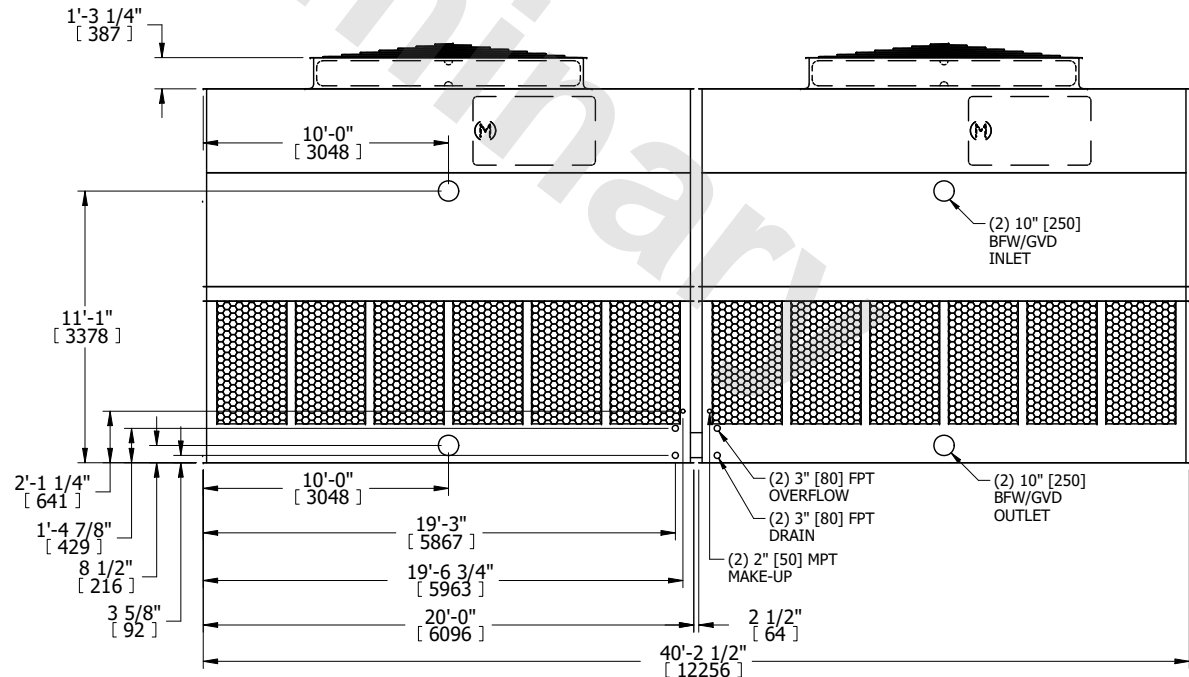

**FACE A**

SHIPPING WEIGHT	25360 lbs+ [11505] kg+	OPERATING WEIGHT	46160 lbs+ [20940] kg+	HEAVIEST SECTION WEIGHT	8420 lbs+ [3820] kg+	NO. OF SHIPPING SECTIONS	4	DRAWN BY:	BLL
-----------------	------------------------	------------------	------------------------	-------------------------	----------------------	--------------------------	---	-----------	-----